

# 1990 TS PARTS DIAGRAM

Crankcase

E1411

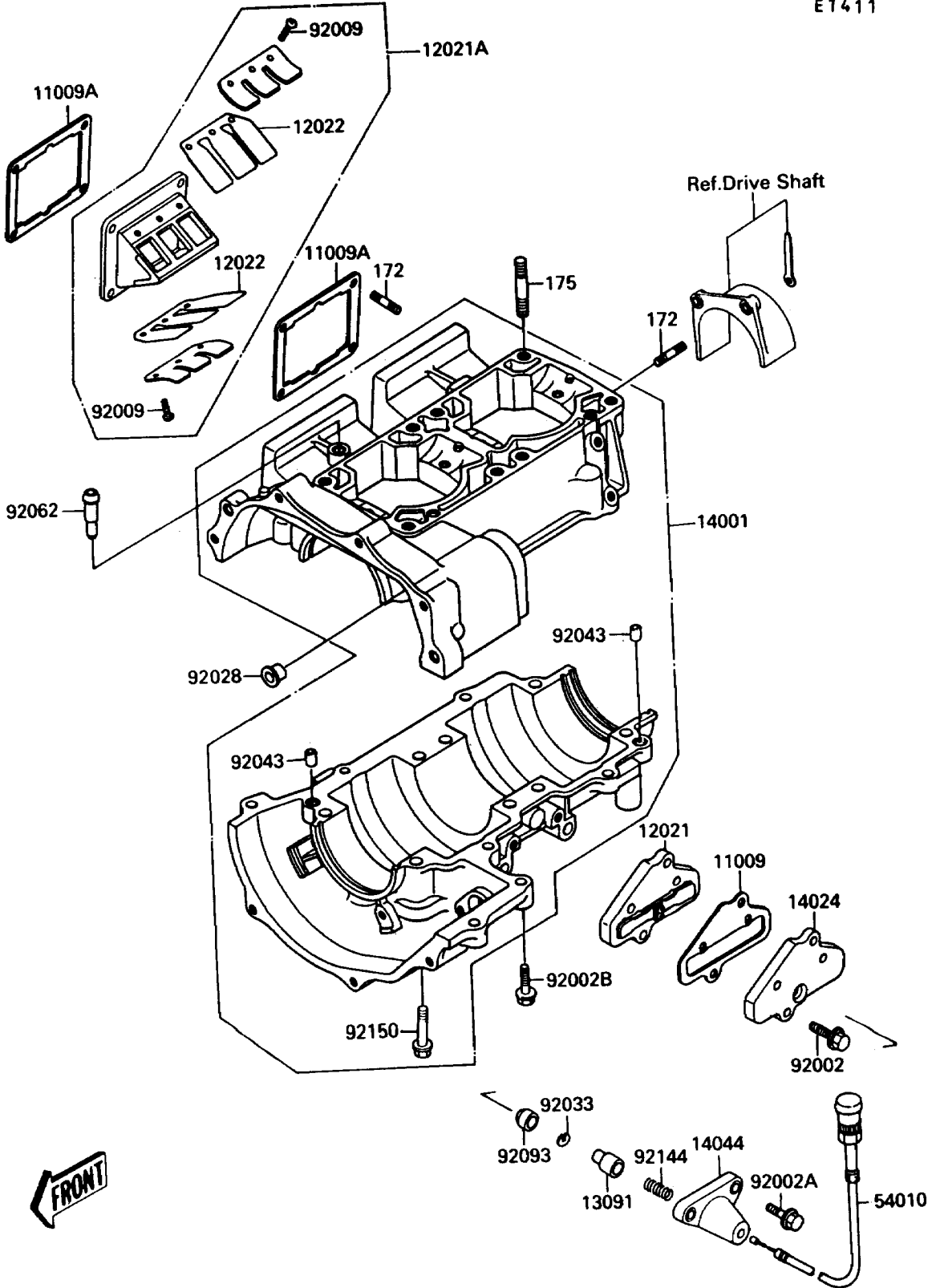

# 1990 TS PARTS LIST

## Crankcase

ITEM NAME	PART NUMBER	QUANTITY
GASKET,CONTROL VALVE (Ref # 11009)	11009-3728	1
GASKET,REED VALVE (Ref # 11009A)	11009-3731	4
VALVE-ASSY-REED,CONTROL (Ref # 12021)	12021-3703	1
VALVE-ASSY-REED (Ref # 12021A)	12021-3704	2
VALVE-REED (Ref # 12022)	12022-1001	4
HOLDER (Ref # 13091)	13091-3707	1
SET-CRANKCASE (Ref # 14001)	14001-3701	1
COVER,CONTROL VALVE (Ref # 14024)	14024-3716	1
HOLDER-CABLE (Ref # 14044)	14044-3702	1
CABLE,CONTROL VALVE (Ref # 54010)	54010-3703	1
BOLT,6X25 (Ref # 92002)	92002-3714	2
BOLT,6X45 (Ref # 92002A)	92002-3717	2
BOLT,6X30 (Ref # 92002B)	92002-3726	7
SCREW,REED VALVE (Ref # 92009)	92009-1014	12
BUSHING (Ref # 92028)	92028-3718	1
RING-SNAP (Ref # 92033)	92033-3708	1
PIN,DOWEL,10X14 (Ref # 92043)	92043-1037	2
NOZZLE (Ref # 92062)	92062-3705	1
SEAL (Ref # 92093)	92093-3703	1
SPRING (Ref # 92144)	92144-3701	1
BOLT,8X65 (Ref # 92150)	92150-3708	8
BOLT-STUD (Ref # 172)	172R0620	10
BOLT-STUD-FINE (Ref # 175)	175R1035	8