

1994 TS PARTS DIAGRAM

Ignition System(JF650-B3/B4/B5/B6)

E1830

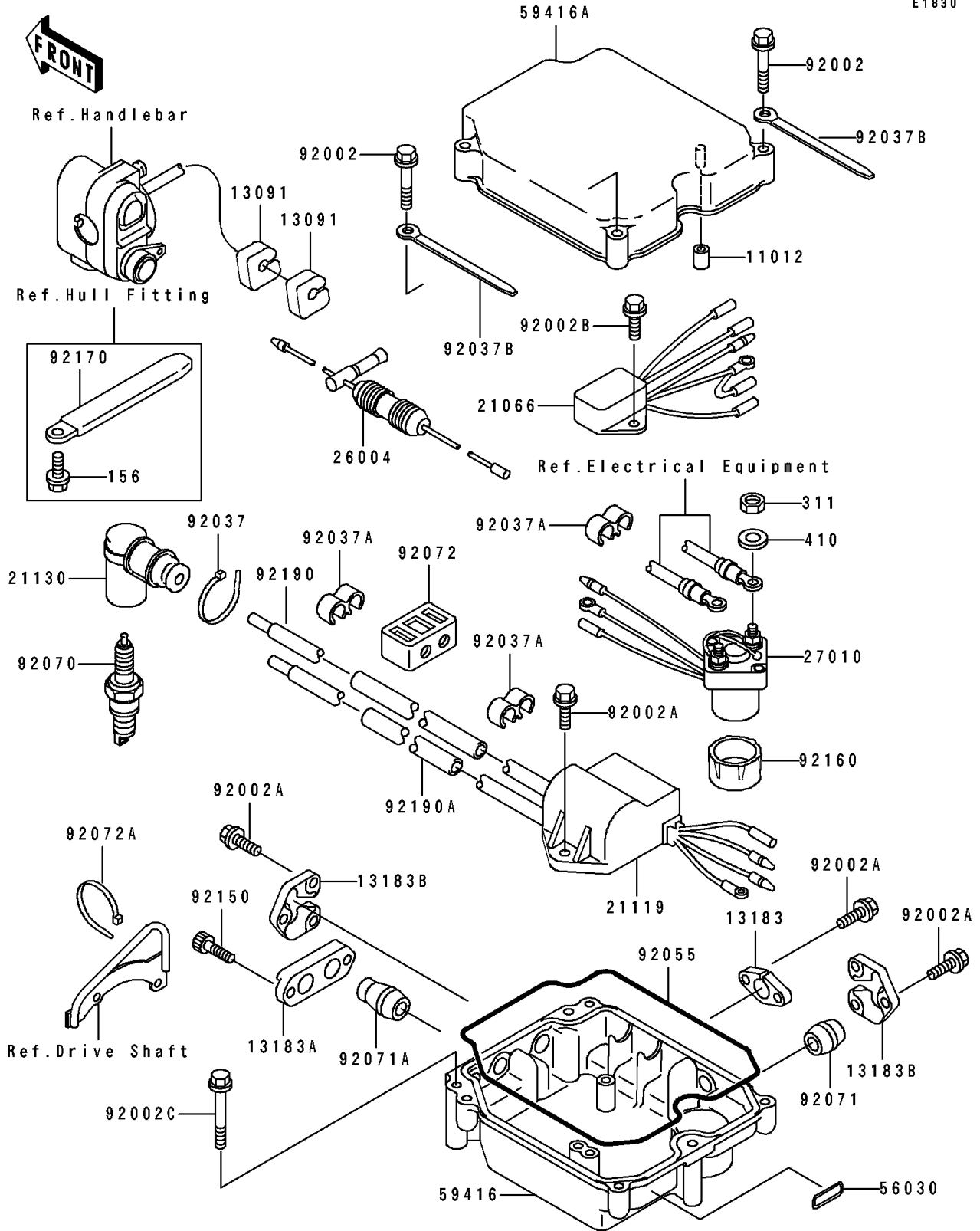

1994 TS PARTS LIST

Ignition System(JF650-B3/B4/B5/B6)

ITEM NAME	PART NUMBER	QUANTITY
CAP (Ref # 11012)	11012-3734	1
HOLDER (Ref # 13091)	13091-3712	2
PLATE (Ref # 13183)	13183-3712	1
PLATE,ELECTRIC BASE (Ref # 13183A)	13183-3767	1
PLATE,ELECTRIC CASE (Ref # 13183B)	13183-3768	2
REGULATOR-VOLTAGE (Ref # 21066)	21066-3708	1
IGNITER (Ref # 21119)	21119-3721	1
CAP-SPARK PLUG (Ref # 21130)	21130-3706	2
FUSE-ASSY (Ref # 26004)	26004-3711	1
SWITCH,STARTER RELAY (Ref # 27010)	27010-3714	1
LABEL,FUSE (Ref # 56030)	56030-3792	1
CASE-ELECTRIC (Ref # 59416)	59416-3723	1
CASE-ELECTRIC (Ref # 59416A)	59416-3724	1
BOLT,6X35 (Ref # 92002)	92002-3715	4
BOLT,6X20 (Ref # 92002A)	92002-3755	10
BOLT,6X12 (Ref # 92002B)	92002-3763	2
BOLT,6X55 (Ref # 92002C)	92002-3772	3
CLAMP (Ref # 92037)	92037-1173	2
CLAMP,HOSE (Ref # 92037A)	92037-1603	3
CLAMP,L=100 (Ref # 92037B)	92037-3736	2
RING-O,ELECTRIC CASE (Ref # 92055)	92055-3715	1
PLUG-SPARK,BR7ES(NGK) (Ref # 92070)	92070-3701	2
GROMMET,ELECTRIC CASE (Ref # 92071)	92071-3765	1
GROMMET,HIGH TENSION CODE (Ref # 92071A)	92071-3778	2
BAND (Ref # 92072)	92072-3754	1
BAND (Ref # 92072A)	92072-3778	2
BOLT,SOCKET,6X18 (Ref # 92150)	92150-3775	2
DAMPER (Ref # 92160)	92160-3729	1
CLAMP (Ref # 92170)	92170-3705	1

1994 TS PARTS LIST

Ignition System(JF650-B3/B4/B5/B6)

ITEM NAME	PART NUMBER	QUANTITY
TUBE,HIGH TENSION,L=330 (Ref # 92190)	92190-3707	1
TUBE,HIGH TENSION,L=210 (Ref # 92190A)	92190-3708	1
BOLT-WP,6X12 (Ref # 156)	156R0612	1
NUT-HEX,6MM (Ref # 311)	311R0600	2
WASHER-PLAIN-SMALL,6MM (Ref # 410)	410S0600	2