

1995 TS PARTS DIAGRAM

Hull Fittings

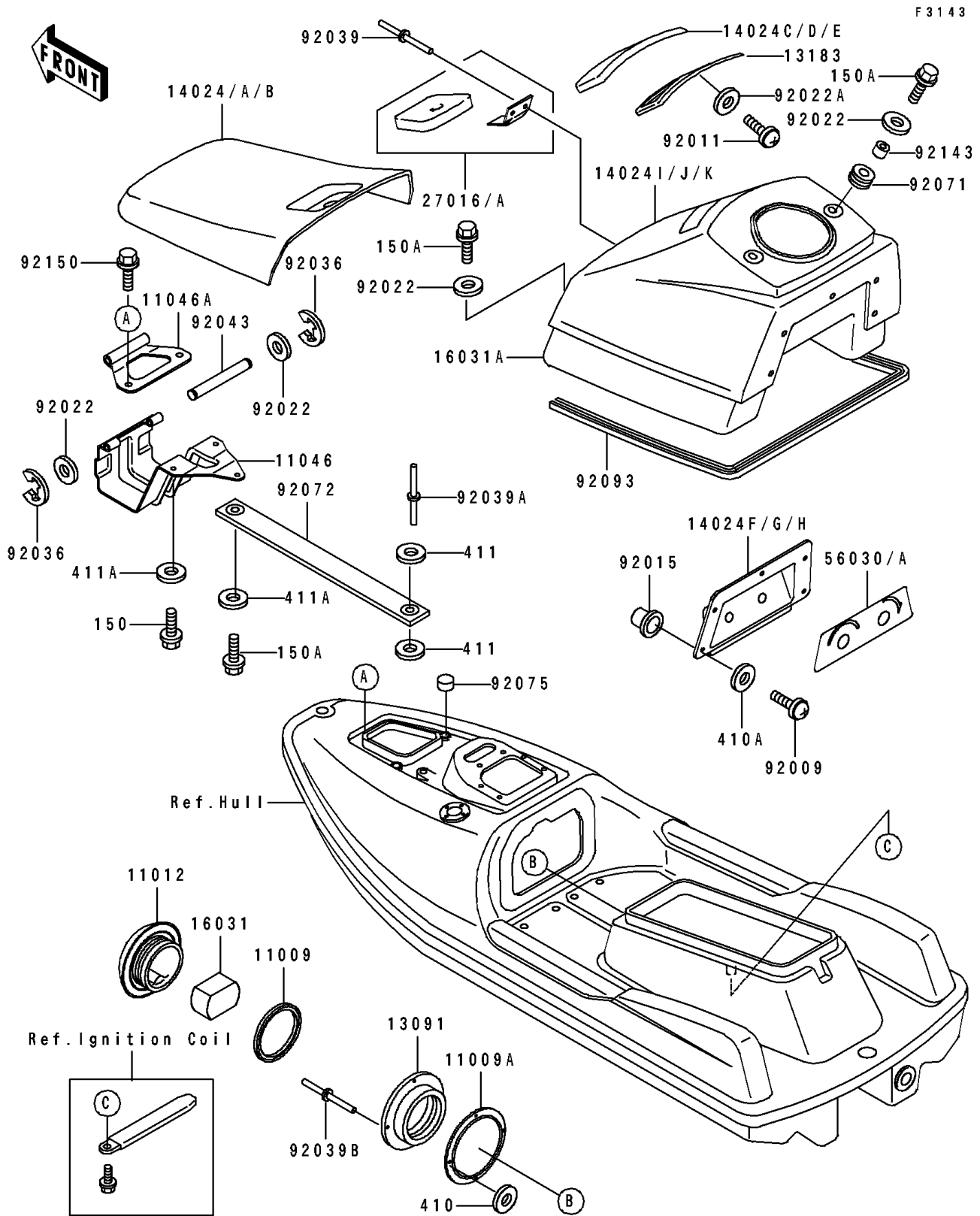

1995 TS PARTS LIST

Hull Fittings

ITEM NAME	PART NUMBER	QUANTITY
GASKET,IGNITION TIMING CAP (Ref # 11009)	11009-3769	1
GASKET,IGNITION TIMING HOLDER (Ref # 11009A)	11009-3770	1
CAP,IGNITION TIMING,J.WHITE (Ref # 11012)	11012-3735-8U	1
BRACKET,HATCH COVER (Ref # 11046)	11046-3838	1
BRACKET,DECK (Ref # 11046A)	11046-3839	1
HOLDER,IGNITION TIMING,J.WHITE (Ref # 13091)	13091-3740-8U	1
PLATE,INLET COVER (Ref # 13183)	13183-3743	1
COVER,HATCH,P.T.GREEN (Ref # 14024B)	14024-3754-TZ	1
COVER,INLET,P.T.GREEN (Ref # 14024E)	14024-3756-TZ	1
COVER,CHOKE,P.T.GREEN (Ref # 14024H)	14024-3757-TZ	1
COVER,HANDLE TOWER,P.T.GREEN (Ref # 14024K)	14024-3758-TZ	1
FLOAT (Ref # 16031)	16031-3769	1
FLOAT (Ref # 16031A)	16031-3775	1
LOCK-ASSY,HATCH (Ref # 27016A)	27016-3725	1
LABEL,FUEL/CHOKE (Ref # 56030A)	56030-3799	1
SCREW,5X20 (Ref # 92009)	92009-3749	5
SCREW (Ref # 92011)	92011-562	6
NUT,5MM (Ref # 92015)	92015-3784	5
WASHER,6.5X20X1.5 (Ref # 92022)	92022-3710	6
WASHER (Ref # 92022A)	92022-563	6
RING-SNAP (Ref # 92036)	92036-518	2
RIVET,4MM (Ref # 92039)	92039-3703	3
RIVET (Ref # 92039A)	92039-3741	1
RIVET (Ref # 92039B)	92039-3742	4
PIN,6X110 (Ref # 92043)	92043-3726	1
GROMMET (Ref # 92071)	92071-3763	2
BAND (Ref # 92072)	92072-3742	1
DAMPER (Ref # 92075)	92075-3760	2
SEAL (Ref # 92093)	92093-3722	1

1995 TS PARTS LIST

Hull Fittings

ITEM NAME	PART NUMBER	QUANTITY
COLLAR,6.2X8X7 (Ref # 92143)	92143-3720	2
BOLT,6X20 (Ref # 92150)	92150-3758	2
BOLT-WS,6X18 (Ref # 150)	150R0618	2
BOLT-WS,6X22 (Ref # 150A)	150R0622	5
W-PLAIN-S,3MM (Ref # 410)	410S0300	4
W-PLAIN-S,5MM (Ref # 410A)	410S0500	5
WASHER-PLAIN,5MM (Ref # 411)	411S0500	2
WASHER-PLAIN,6MM (Ref # 411A)	411S0600	3