

1996 TS PARTS DIAGRAM

Crankcase

E1411

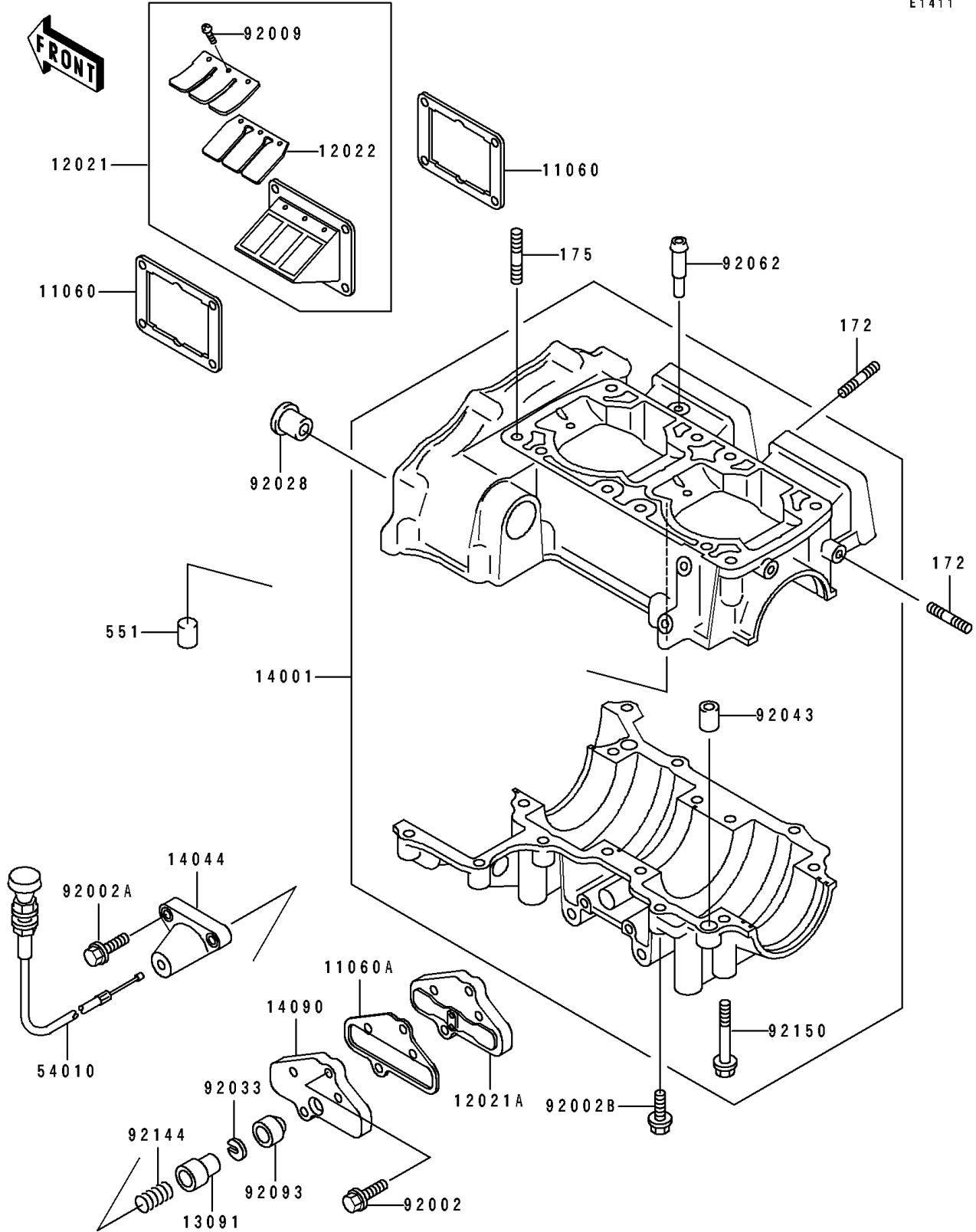

1996 TS PARTS LIST

Crankcase

| ITEM NAME | PART NUMBER | QUANTITY |
|---|-------------|----------|
| GASKET, REED VALVE (Ref # 11060) | 11060-3703 | 4 |
| GASKET, CONTROL VALVE (Ref # 11060A) | 11060-3723 | 1 |
| VALVE-ASSY-REED (Ref # 12021) | 12021-3704 | 2 |
| VALVE-ASSY-REED, CONTROL (Ref # 12021A) | 12021-3707 | 1 |
| VALVE-REED (Ref # 12022) | 12022-1001 | 4 |
| HOLDER (Ref # 13091) | 13091-3707 | 1 |
| SET-CRANKCASE (Ref # 14001) | 14001-5347 | 1 |
| HOLDER-CABLE (Ref # 14044) | 14044-3702 | 1 |
| COVER, CONTROL VALVE (Ref # 14090) | 14090-3734 | 1 |
| CABLE, CONTROL VALVE (Ref # 54010) | 54010-3708 | 1 |
| BOLT, 6X25 (Ref # 92002) | 92002-3714 | 2 |
| BOLT, 6X45 (Ref # 92002A) | 92002-3717 | 2 |
| BOLT, 6X30 (Ref # 92002B) | 92002-3726 | 7 |
| SCREW, REED VALVE (Ref # 92009) | 92009-1014 | 12 |
| BUSHING (Ref # 92028) | 92028-3718 | 1 |
| RING-SNAP (Ref # 92033) | 92033-3708 | 1 |
| PIN, DOWEL, 10X14 (Ref # 92043) | 92043-1037 | 2 |
| NOZZLE (Ref # 92062) | 92062-3705 | 1 |
| SEAL (Ref # 92093) | 92093-3703 | 1 |
| SPRING (Ref # 92144) | 92144-3701 | 1 |
| BOLT, 8X65 (Ref # 92150) | 92150-3708 | 8 |
| BOLT-STUD (Ref # 172) | 172R0620 | 10 |
| BOLT-STUD-FINE (Ref # 175) | 175R1035 | 8 |
| PIN-DOWEL (Ref # 551) | 551R0612 | 1 |