

1983 KX60 PARTS DIAGRAM

CARBURETOR (KX60-A1)

E1611-0094

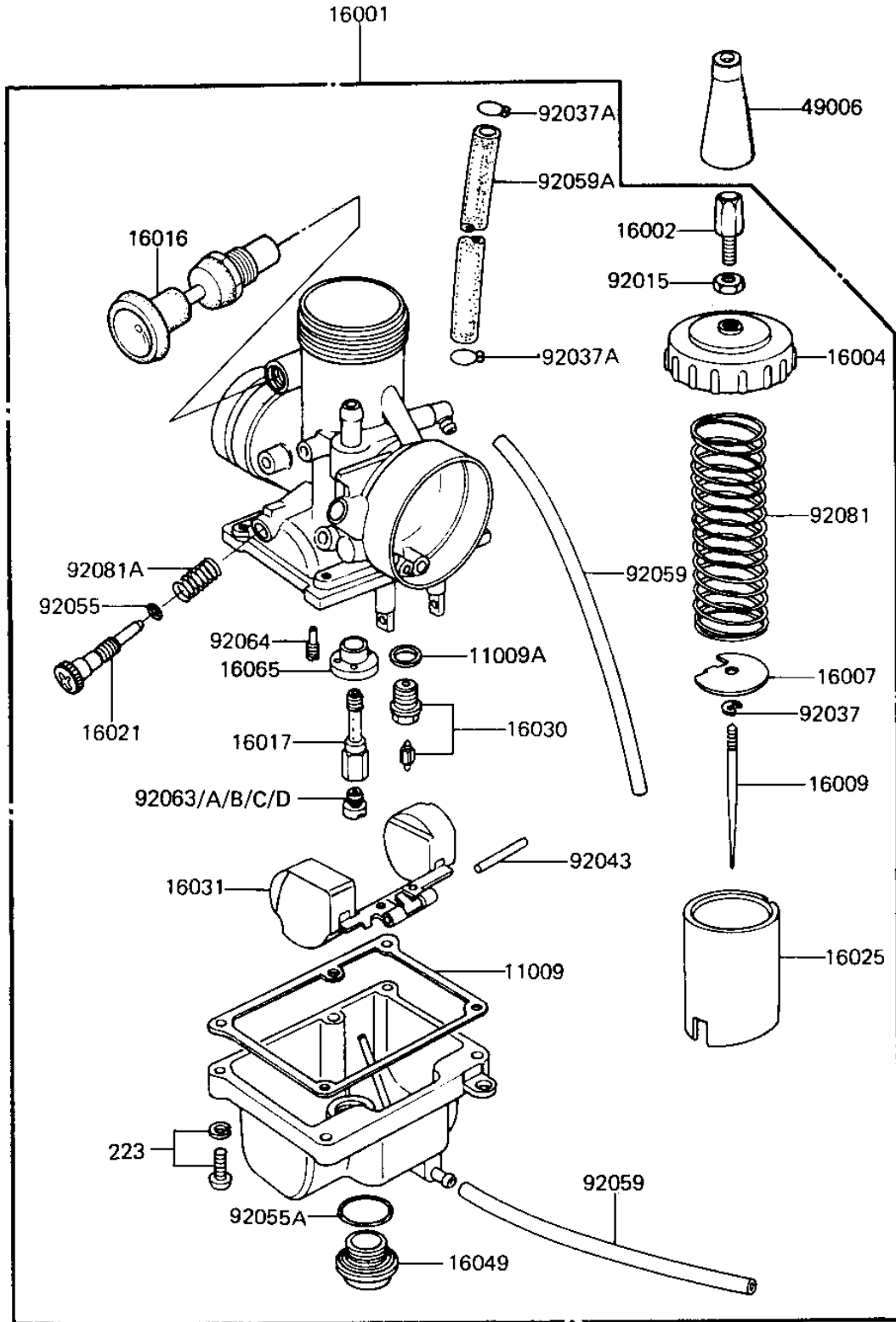

1983 KX60 PARTS LIST

CARBURETOR (KX60-A1)

ITEM NAME	PART NUMBER	QUANTITY
GASKET,FLOAT CHAMBER (Ref # 11009)	11009-1147	1
WASHER FLOAT VLV SEAT (Ref # 11009A)	16029-004	1
CARBURETOR (Ref # 16001)	16001-1548	1
ADJUSTER,CABLE (Ref # 16002)	16002-017	1
CAP,MIXING CHAMBER (Ref # 16004)	16004-025	1
SPRING SEAT,THRTL VL (Ref # 16007)	16007-023	1
NEEDLE-JET,5113-2 (Ref # 16009)	16009-1128	1
PLUNGER (Ref # 16016)	16016-1027	1
JET NEEDLE, 0-2 (Ref # 16017)	16017-1123	1
SCREW-THROTTLE STOP (Ref # 16021)	16021-1042	1
VALVE,THROTTLE,C.A1.5 (Ref # 16025)	16025-1028	1
FLOAT VALVE ASSY (Ref # 16030)	16030-005	1
FLOAT (Ref # 16031)	16031-1005	1
COVER,MAIN JET (Ref # 16049)	16049-1001	1
HOLDER,NEEDLE JET (Ref # 16065)	16065-1020	1
CAP,CARBURETOR (Ref # 49006)	16036-007	1
NUT-CABLE ADJUST LOCK (Ref # 92015)	16003-006	1
CIRCLIP (Ref # 92037)	16008-010	1
CLAMP-PIPE (Ref # 92037A)	92037-072	2
FLOAT PIN (Ref # 92043)	16032-003	1
"0" RING (Ref # 92055)	92055-044	1
"0" RING,MAIN JET COV (Ref # 92055A)	92055-1061	1
TUBE,3X5X300 (Ref # 92059)	92059-1755	2
TUBE,5.3X10.5X150 (Ref # 92059A)	92059-1129	1
MAIN JET NO 125R (Ref # 92063)	92063-055	1
JET-MAIN,#A127.5 (Ref # 92063A)	92063-1100	1
MAIN JET NO 130R (Ref # 92063B)	92063-057	1
MAIN JET NO 120R (Ref # 92063C)	92063-078	1
JET-MAIN,#A122.5 (Ref # 92063D)	92063-1101	1

1983 KX60 PARTS LIST

CARBURETOR (KX60-A1)

ITEM NAME	PART NUMBER	QUANTITY
JET-PILOT,#45 (Ref # 92064)	92064-1060	1
SPRING,THROTTLE VALV (Ref # 92081)	16006-023	1
SPRING,THROTTLE ADJST (Ref # 92081A)	92081-1152	1
SCREW-PAN-WS-CROS (Ref # 223)	223B0416	4