

# 1985 Police 1000 PARTS DIAGRAM

## SWING ARM/SHOCK ABSORBERS

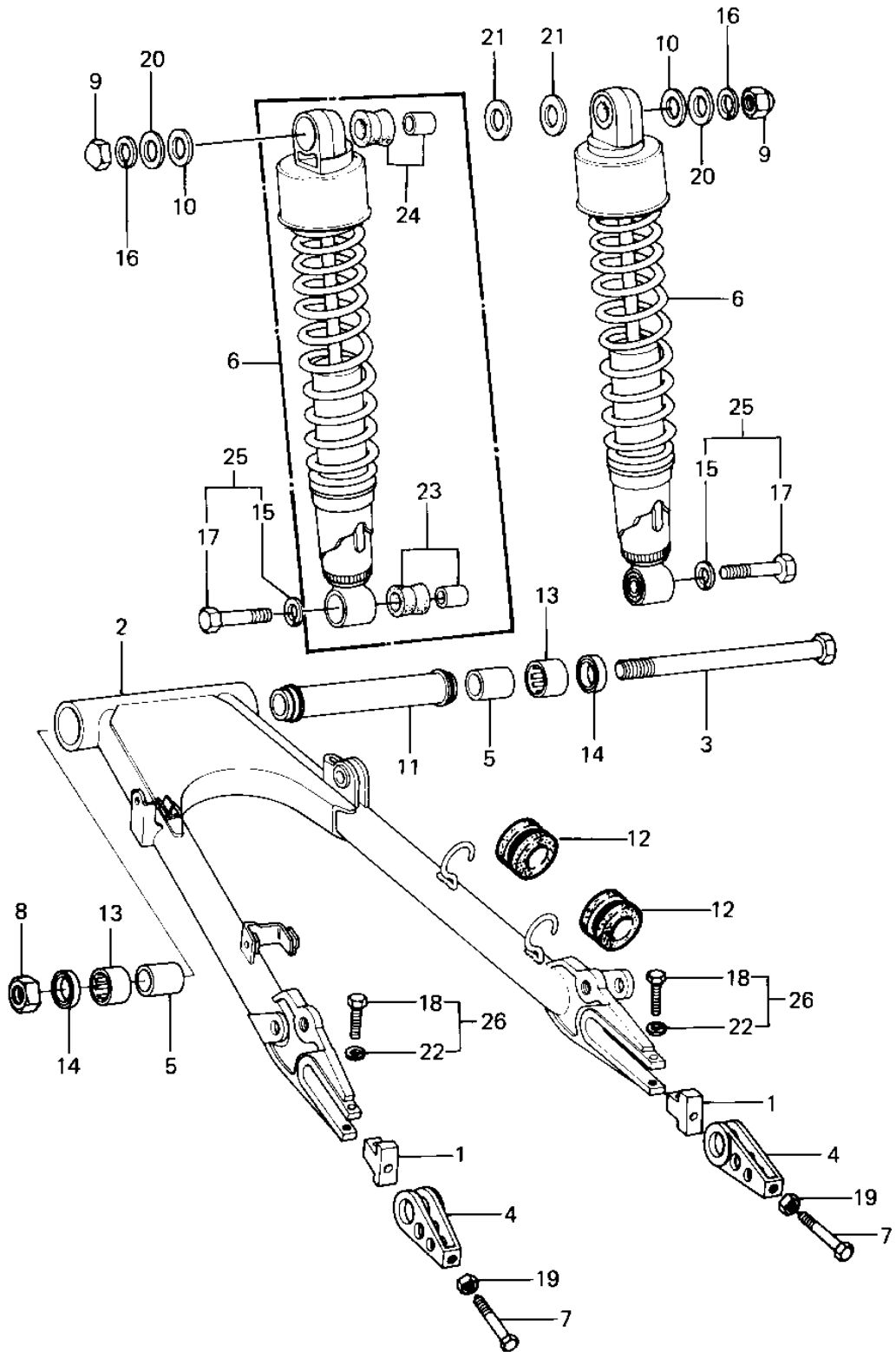

# 1985 Police 1000 PARTS LIST

## SWING ARM/SHOCK ABSORBERS

ITEM NAME	PART NUMBER	QUANTITY
STOPPER,CHAIN ADJUST (Ref # 1)	33044-001	
ARM-COMP-SWING (Ref # 2)	33001-4005	
ARM-COMP-SWING (Ref # 2)	33001-4006	
SHAFT,SWING ARM PIVOT (Ref # 3)	33032-036	
ADJUSTER,CHAIN (Ref # 4)	33040-066	
SLEEVE,SWING ARM (Ref # 5)	42036-1040	
SHOCK ABSBR RR (Ref # 6)	45014-1174	
BOLT-CHN ADJUST 10MM (Ref # 7)	92001-143	
NUT-SELF LOCKING (Ref # 8)	92019-012	
NUT 12MM (Ref # 9)	92020-014	
WASHER,12.4X28X2.3 (Ref # 10)	92022-1239	
COLLAR,SWING ARM,L=15 (Ref # 11)	92027-1301	
COLLAR (Ref # 11)	92027-1561	
DAMPER RUBBER (Ref # 12)	43064-007	
BEARING-NEEDLE (Ref # 13)	92046-1035	
SEAL-OIL (Ref # 14)	92049-1060	
WASHER SPRING 10MM (Ref # 15)	461F1000	
WASHER SPRING 12MM (Ref # 16)	461F1200	
BOLT HEX HEAD 10X35 (Ref # 17)	113N1035	
BOLT,8X40 (Ref # 18)	115G0840	
NUT 10MM (Ref # 19)	315B1000	
WASHER PLAIN 12MM (Ref # 20)	410B1200	
WASHER PLAIN 14MM (Ref # 21)	410B1400	
WASHER SPRING 6MM (Ref # 22)	461F0600	
BUSHING,SHOCK ABSORBE (Ref # 23)	45017-019	
BUSHING,SHOCK ABSORBE (Ref # 24)	92075-1141	
BOLT-FINE-WS (Ref # 25)	160N1035	
BOLT-UPSET-WS-SMALL (Ref # 26)	183G0840	