

1981 KX250 PARTS DIAGRAM

FRAME/FRAME FITTINGS (KX250-A7)

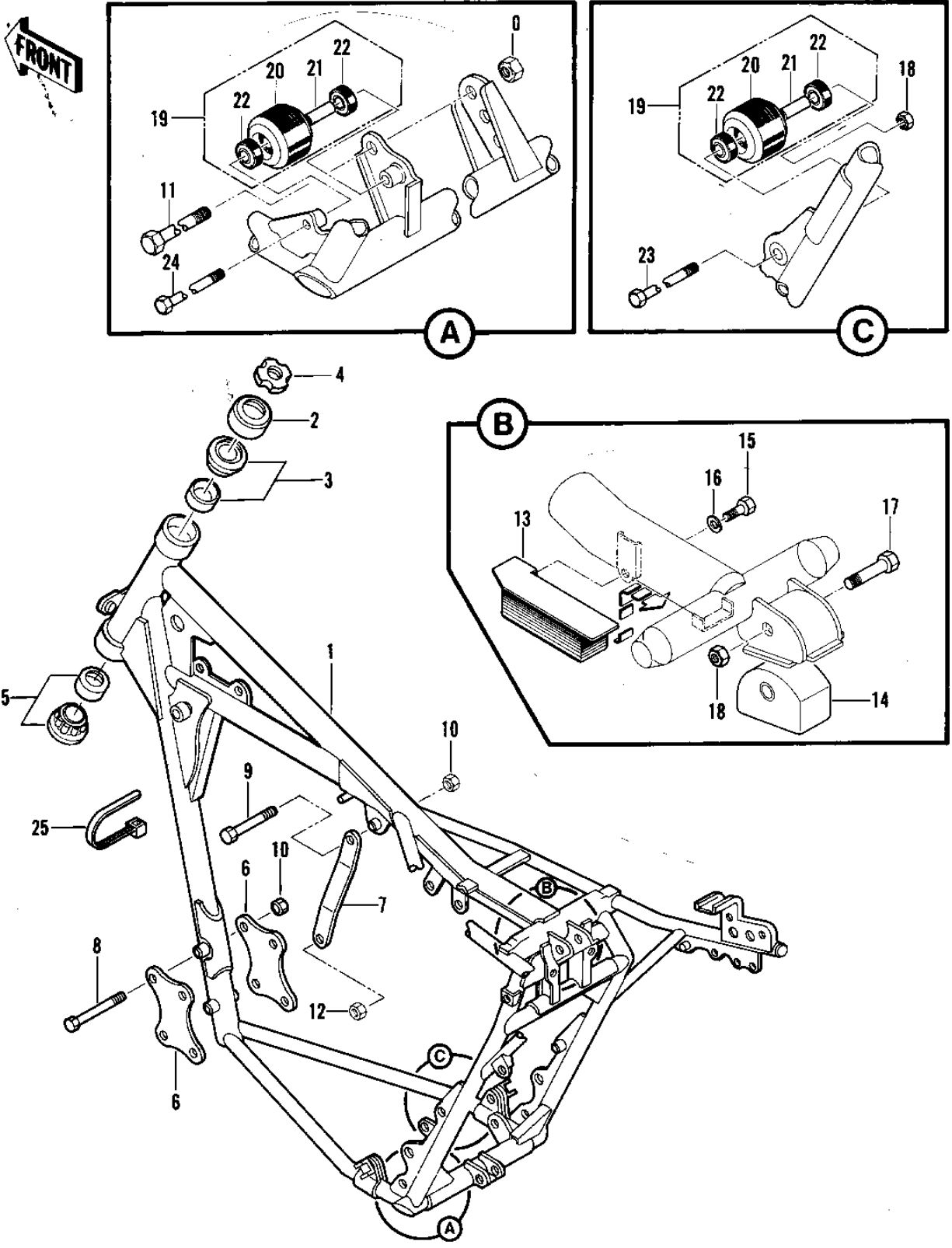

1981 KX250 PARTS LIST

FRAME/FRAME FITTINGS (KX250-A7)

ITEM NAME	PART NUMBER	QUANTITY
FRAME (Ref # 1)	32002-1231	1
CAP,STEERING STEM (Ref # 2)	46098-015	1
BEARING,STEERING STEM (Ref # 3)	92047-017	1
NUT (Ref # 4)	92015-1546	1
BEARING,ROLLER,32006 (Ref # 5)	92116-1008	1
BRACKET,ENGINE (Ref # 6)	32029-1112	1
BRACKET,ENGINE (Ref # 7)	32029-4016	1
BOLT HEX HEAD,10X66.5 (Ref # 8)	92001-1033	1
BOLT (Ref # 9)	92001-1412	1
NUT,LOCK,10MM (Ref # 10)	92019-021	1
BOLT,HEX HEAD,10X127 (Ref # 11)	92001-4001	1
NUT,10MM (Ref # 12)	92015-1415	1
DAMPER,REAR SHOCK (Ref # 13)	92075-1249	1
DAMPER UNITRAK (Ref # 14)	92075-4025	1
BOLT SMALL (Ref # 15)	114G0812	1
WASHER, SPRING, 8MM (Ref # 16)	461F0800	1
BOLT,HEX,SMALL, 8X40 (Ref # 17)	115G0840	1
NUT,LOCK,8MM (Ref # 18)	92015-1124	1
ROLLER,ASSY (Ref # 19)	92122-1013	1
ROLLER (Ref # 20)	92122-1014	1
COLLAR (Ref # 21)	92027-1081	1
BEARING,BALL (Ref # 22)	92045-1009	1
BOLT-SMALL-UPSET,8X55 (Ref # 23)	115G0855	1
BOLT HEX HEAD 8X70 (Ref # 24)	114B0870	1
BAND (Ref # 25)	92072-3509	1