

1983 LTD PARTS DIAGRAM

CRANKSHAFT ('81-'83 H2/H3/H4)

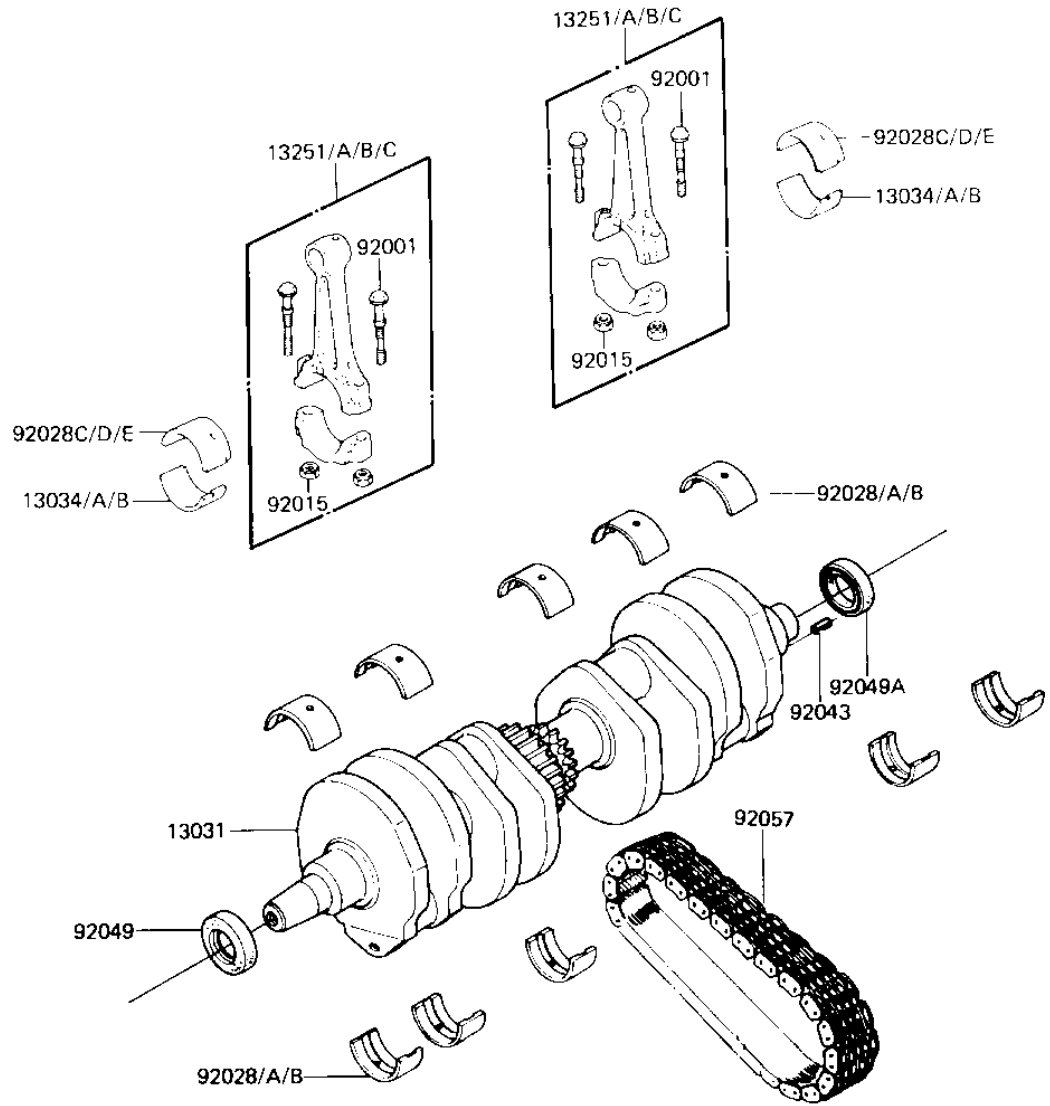

E1321-0034



1983 LTD PARTS LIST

CRANKSHAFT ('81-'83 H2/H3/H4)

ITEM NAME	PART NUMBER	QUANTITY
CRANKSHAFT ASSY (Ref # 13031)	13031-1028	1
METAL,CONNECT ROD BRG (Ref # 13034)	13034-050	4
METAL,CONNECT ROD BRG (Ref # 13034A)	13034-051	4
METAL,CONNECT ROD BRG (Ref # 13034B)	13034-052	4
ROD-ASSY-CONNECTING,I (Ref # 13251)	13251-1009-II	4
ROD-ASSY-CONNECTING,I (Ref # 13251A)	13251-1009-II	4
ROD-ASSY-CONNECTING,J (Ref # 13251B)	13251-1009-JJ	4
CONNECTING ROD ASSY,K (Ref # 13251C)	13251-1007-KK	4
BOLT,CONNECTING ROD,8 (Ref # 92001)	92001-1887	8
NUT,FLANGED,8MM (Ref # 92015)	92015-1311	8
BUSHING,CRANKSHAFT (Ref # 92028)	92028-1100	10
BUSHING,CRANKSHAFT (Ref # 92028A)	92028-1101	10
BUSHING,CRANKSHAFT (Ref # 92028B)	92028-1102	10
BUSHING,CONNECTING RO (Ref # 92028C)	92028-1156	4
BUSHING,CONNECTING RO (Ref # 92028D)	92028-1157	4
BUSHING,CONNECTING RO (Ref # 92028E)	92028-1158	4
PIN-SPRING,4X8 (Ref # 92043)	555A0408	1
OIL SEAL,HSCY22397 (Ref # 92049)	92050-080	1
OIL SEAL,HSCY25397 (Ref # 92049A)	92050-081	1
CHAIN,PRIMARY 52L (Ref # 92057)	13122-007	1