

# 1983 LTD PARTS DIAGRAM

CRANKCASE BOLT & STUD PATTERN ('81-'83 H)

E1412-0002

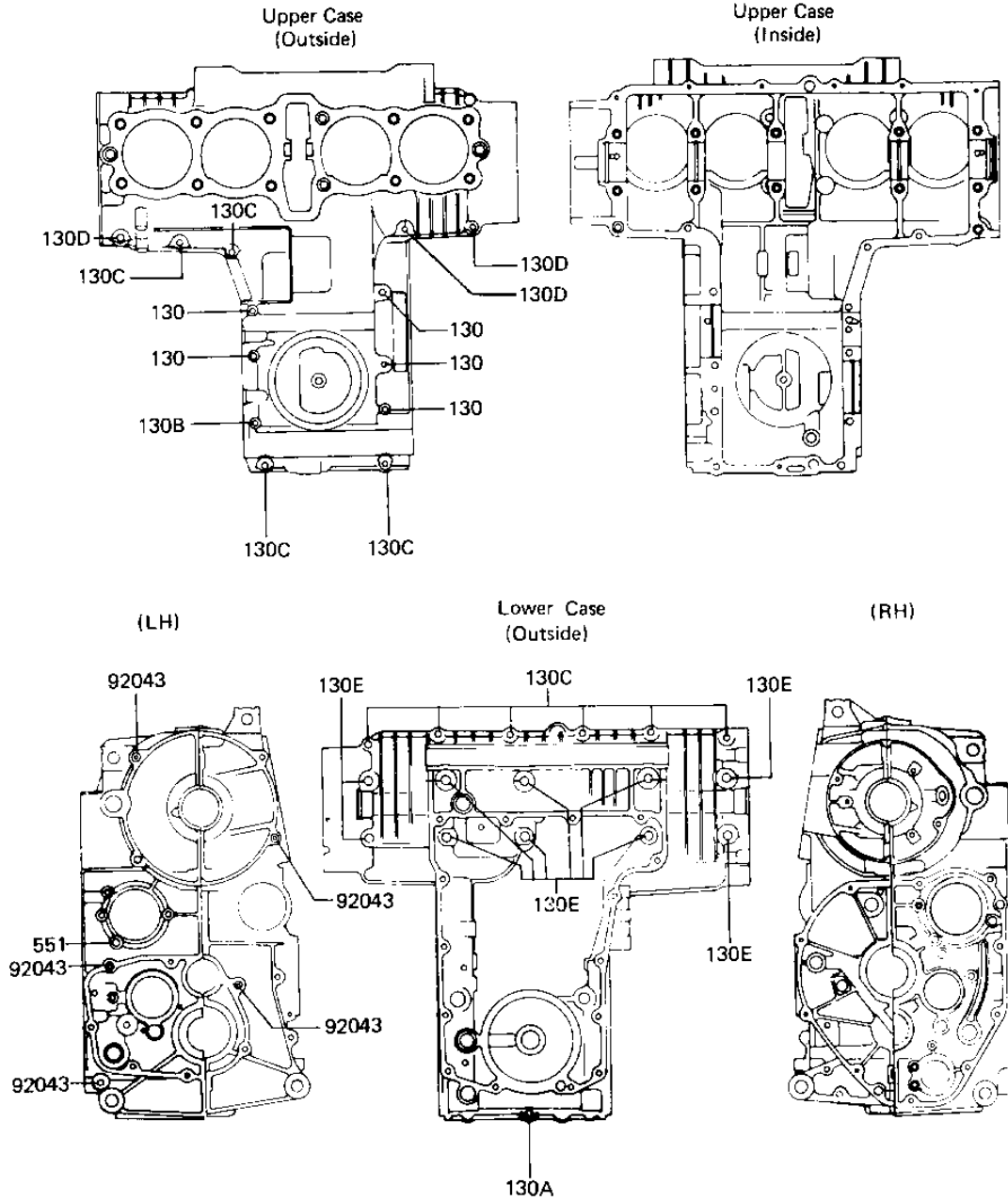

## 1983 LTD PARTS LIST

CRANKCASE BOLT & STUD PATTERN ('81-'83 H

ITEM NAME	PART NUMBER	QUANTITY
PIN-DOWEL (Ref # 92043)	92042-007	5
BOLT-FLANGED,6X100 (Ref # 130)	130G06100	5
BOLT-FLANGED,6X105 (Ref # 130A)	130G06105	1
BOLT-FLANGED,6X115 (Ref # 130B)	130G06115	1
BOLT,FLANGED,6X40 (Ref # 130C)	130G0640	9
BOLT-FLANGED,6X50 (Ref # 130D)	130G0650	1
BOLT-FLANGED,8X95 (Ref # 130E)	130P0895	10
PIN,DOWEL,6X14 (Ref # 551)	551A0614	1