

1981 LTD PARTS DIAGRAM

GEAR CHANGE MECHANISM ('81-'83 H2/H3/H4)

E 1370 0003

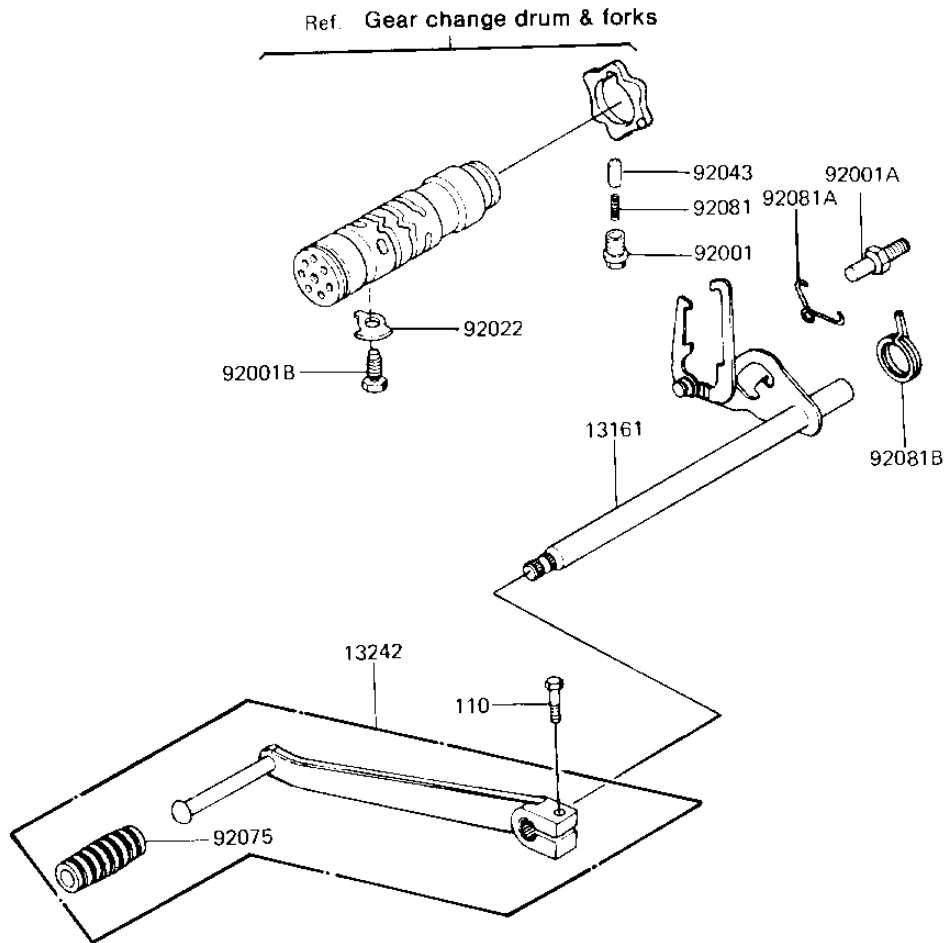

1981 LTD PARTS LIST

GEAR CHANGE MECHANISM ('81-'83 H2/H3/H4)

ITEM NAME	PART NUMBER	QUANTITY
LEVER ASSY,GEAR SFT (Ref # 13161)	13161-042	1
PEDAL ASSY,CHANGE (Ref # 13242)	13242-1031	1
BOLT,NEUTRAL POSITION (Ref # 92001)	92001-1037	1
BOLT,RETURN SPRING (Ref # 92001A)	92001-1401	1
BOLT,HEX HEAD,10X26 (Ref # 92001B)	92001-174	1
WASHER,LOCK,10MM (Ref # 92022)	92024-074	1
PIN-NEUTRAL POSITION (Ref # 92043)	92043-076	1
DAMPER,CHANGE PEDAL (Ref # 92075)	92160-1036	1
SPRING (Ref # 92081)	92081-112	1
SPRING,KICK PAWL (Ref # 92081A)	92083-018	1
SPRING,CHG PEDL RTRN (Ref # 92081B)	92083-028	1
BOLT-UPSET,6X20 (Ref # 110)	112G0620	1