

1981 KZ550-A2 PARTS DIAGRAM

CARBURETOR PARTS ('80-'81 A1/A2)

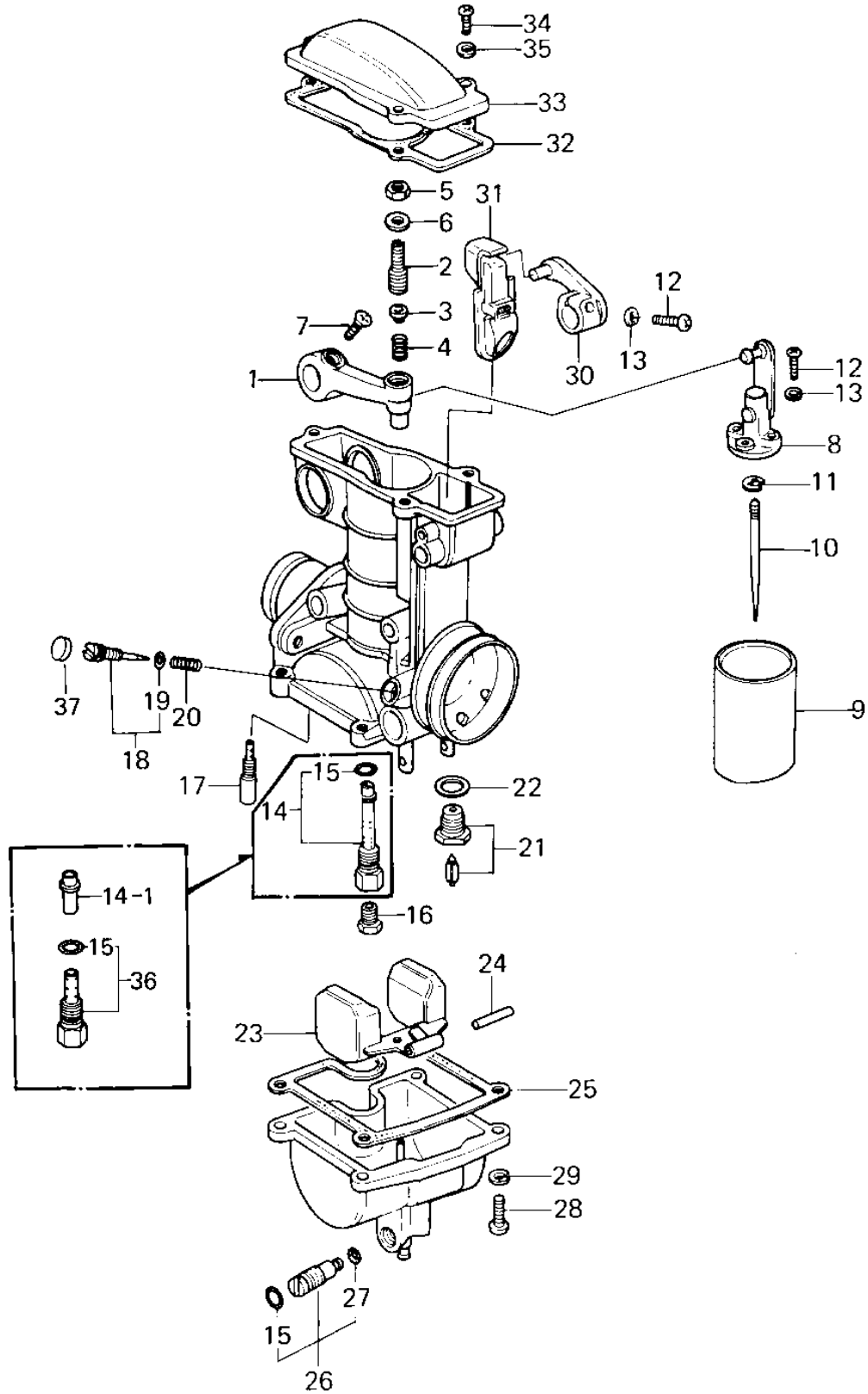

1981 KZ550-A2 PARTS LIST

CARBURETOR PARTS ('80-'81 A1/A2)

ITEM NAME	PART NUMBER	QUANTITY
ARM,THROTTLE (Ref # 1)	21083-1006	4
SCREW,ADJUST,THROTTLE (Ref # 2)	92009-1079	4
PIN,SPRING,THROTTLE (Ref # 3)	92043-1065	4
SPRING,THROTTLE ARM (Ref # 4)	92081-1189	4
NUT 5MM (Ref # 5)	312B0500	4
WASHER,PLAIN (Ref # 6)	92022-1167	4
SCREW.CNTSNK HD,4X12 (Ref # 7)	92009-1080	4
BRACKET ASSY,THROTTLE (Ref # 8)	11034-1587	4
VALVE,THROTTLE,CA2.5 (Ref # 9)	16025-1038	4
JET NEEDLE,#4D92 (Ref # 10)	16009-1060	4
JET NEEDLE,#4D93 (Ref # 10)	16009-1061	4
CIRCLIP,JET NEEDLE (Ref # 11)	92037-1157	4
SCREW PAN HEAD 3X12 (Ref # 12)	220B0312	12
WASHER SPRING 3MM (Ref # 13)	461F0300	12
NEEDLE JET,#V95 (Ref # 14)	16017-1044	4
NEEDLE JET,#V95 (Ref # 14-1)	16017-1057	4
"O"RING,5M/M (Ref # 15)	92055-1069	8
MAIN JET,#92 (Ref # 16)	92063-1055	4
PILOT JET #32 (Ref # 17)	92064-1028	4
SCREW,AIR ADJUSTING (Ref # 18)	16014-1024	4
SCREW,AIR ADJUSTING (Ref # 18)	16014-1019	4
"O" RING,AIR SCREW (Ref # 19)	92055-1070	4
SPRING,AIR SCREW (Ref # 20)	92081-1190	4
FLOAT VALVE ASSY. (Ref # 21)	16030-1009	4
GASKET,FLOAT VALVE (Ref # 22)	11009-1160	4
FLOAT (Ref # 23)	16031-1009	4
PIN (Ref # 24)	92043-1066	4
GASKET,FLOAT CHAMBER (Ref # 25)	11009-1161	4
SCREW,DRAIN (Ref # 26)	92066-1065	4

1981 KZ550-A2 PARTS LIST

CARBURETOR PARTS ('80-'81 A1/A2)

ITEM NAME	PART NUMBER	QUANTITY
"O" RING,OVERFLOW (Ref # 27)	92055-1071	4
SCREW PAN HEAD 4X16 (Ref # 28)	220B0416	16
WASHER SPRING 4MM (Ref # 29)	461F0400	16
ARM,CHOKE (Ref # 30)	21083-1007	4
VALVE ASSY,CHOKE (Ref # 31)	16126-1024	4
GASKET,MIXING CHAMBER (Ref # 32)	11009-1162	4
TOP,MIXING CHAMBER (Ref # 33)	16005-1008	4
SCREW-PAN-CROS (Ref # 34)	220B0414	12
WASHER SPRING 4MM (Ref # 35)	461F0400	12
PIPE,BLEED (Ref # 36)	49122-1010	4
PLUG,PILOT SCREW (Ref # 37)	92066-1051	4