

1983 KZ550-A4 PARTS DIAGRAM

FRONT FORK (KZ550-A3)

F2340-0055

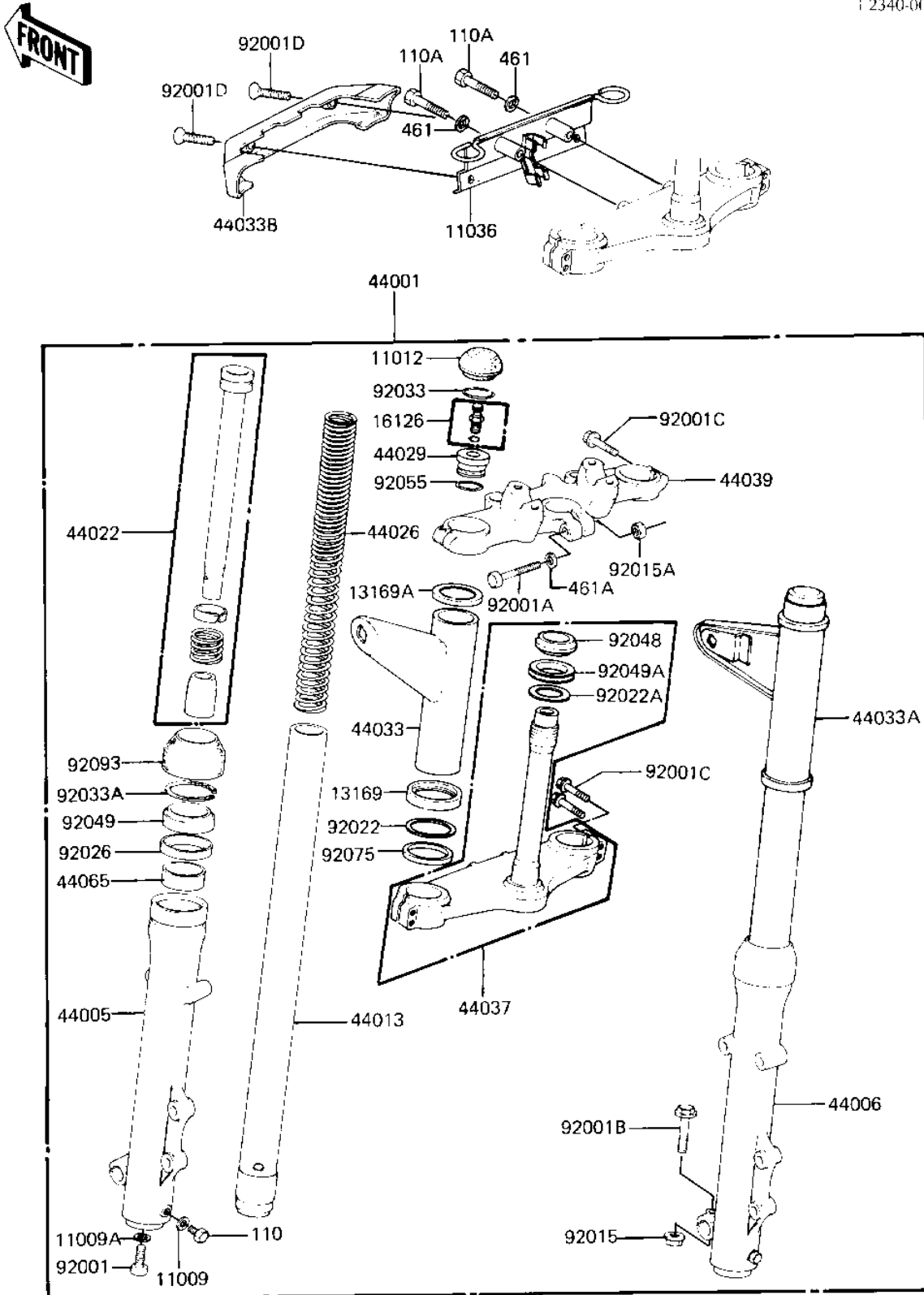

1983 KZ550-A4 PARTS LIST

FRONT FORK (KZ550-A3)

ITEM NAME	PART NUMBER	QUANTITY
GASKET,DRAIN PLUG (Ref # 11009)	44045-047	2
GASKET,FORK CYL BOLT (Ref # 11009A)	44045-051	2
CAP, FORK TOP (Ref # 11012)	11012-1151	2
BRACKET-A (Ref # 11036)	11036-1210	1
GUIDE,FORK COVER,LOW (Ref # 13169)	13169-1134	2
GUIDE,FORK COVER,UPPE (Ref # 13169A)	13169-1135	2
VALVE ASSY,AIR (Ref # 16126)	16126-1025	2
FORK-FRONT (Ref # 44001)	44001-1309	1
TUBE,LH,FORK OUTER (Ref # 44005)	44005-1057	1
TUBE,RH,FORK OUTER (Ref # 44006)	44006-1057	1
PIPE-FORK INNER (Ref # 44013)	44013-1044	2
CYLINDER-FORK (Ref # 44022)	44022-1051	2
SPRING,FORK INNER (Ref # 44026)	44026-1077	2
SEAT,FORK SPRING (Ref # 44029)	44029-1019	2
COVER-FORK,LH,BLACK (Ref # 44033)	44033-1058	1
COVER-FORK,RH,BLACK (Ref # 44033A)	44033-1059	1
COVER-FORK (Ref # 44033B)	44033-1073	1
STEM,STEERING (Ref # 44037)	44037-1013	1
HEAD,STEERING STEM (Ref # 44039)	44039-1011	1
BUSHING, FORK (Ref # 44065)	44065-1011	2
BOLT,FORK CYLINDER (Ref # 92001)	44041-078	2
BOLT,HEX HEAD,8X55 (Ref # 92001A)	92001-1064	1
BOLT,HEX HEAD,8X45 (Ref # 92001B)	92001-1136	1
BOLT,8X40 (Ref # 92001C)	92001-1149	6
SCREW-CSK-RD-CROS (Ref # 92001D)	222C0518	2
NUT,8MM (Ref # 92015)	92015-1055	1
NUT,LOCK,8MM (Ref # 92015A)	92015-1124	1
WASHER,FORK COVER (Ref # 92022)	92022-1111	2
WASHER,PLAIN (Ref # 92022A)	92022-231	2

1983 KZ550-A4 PARTS LIST

FRONT FORK (KZ550-A3)

ITEM NAME	PART NUMBER	QUANTITY
SPACER,FORK (Ref # 92026)	92026-1038	2
CIRCLIP,FORK TOP (Ref # 92033)	92033-1023	2
RING,SNAP (Ref # 92033A)	92033-1055	2
CONE,STEERING STEM (Ref # 92048)	92047-012	1
SEAL-OIL,FORK (Ref # 92049)	92049-1063	2
OIL SEAL,STEERING STM (Ref # 92049A)	92056-003	1
"O" RING (Ref # 92055)	92055-1034	2
DAMPER RUBBER,FORK (Ref # 92075)	92075-1137	2
SEAL,DUST (Ref # 92093)	92093-1047	2
BOLT HEX HEAD 6X8 (Ref # 110)	110B0608	2
BOLT,6X40 (Ref # 110A)	110C0640	2
WASHER SPRING 6MM (Ref # 461)	461F0600	2
WASHER SPRING 8MM (Ref # 461A)	461F0800	1