

1981 LTD PARTS DIAGRAM

CRANKSHAFT/SECONDARY SHAFT ('80-'81 C1/C)

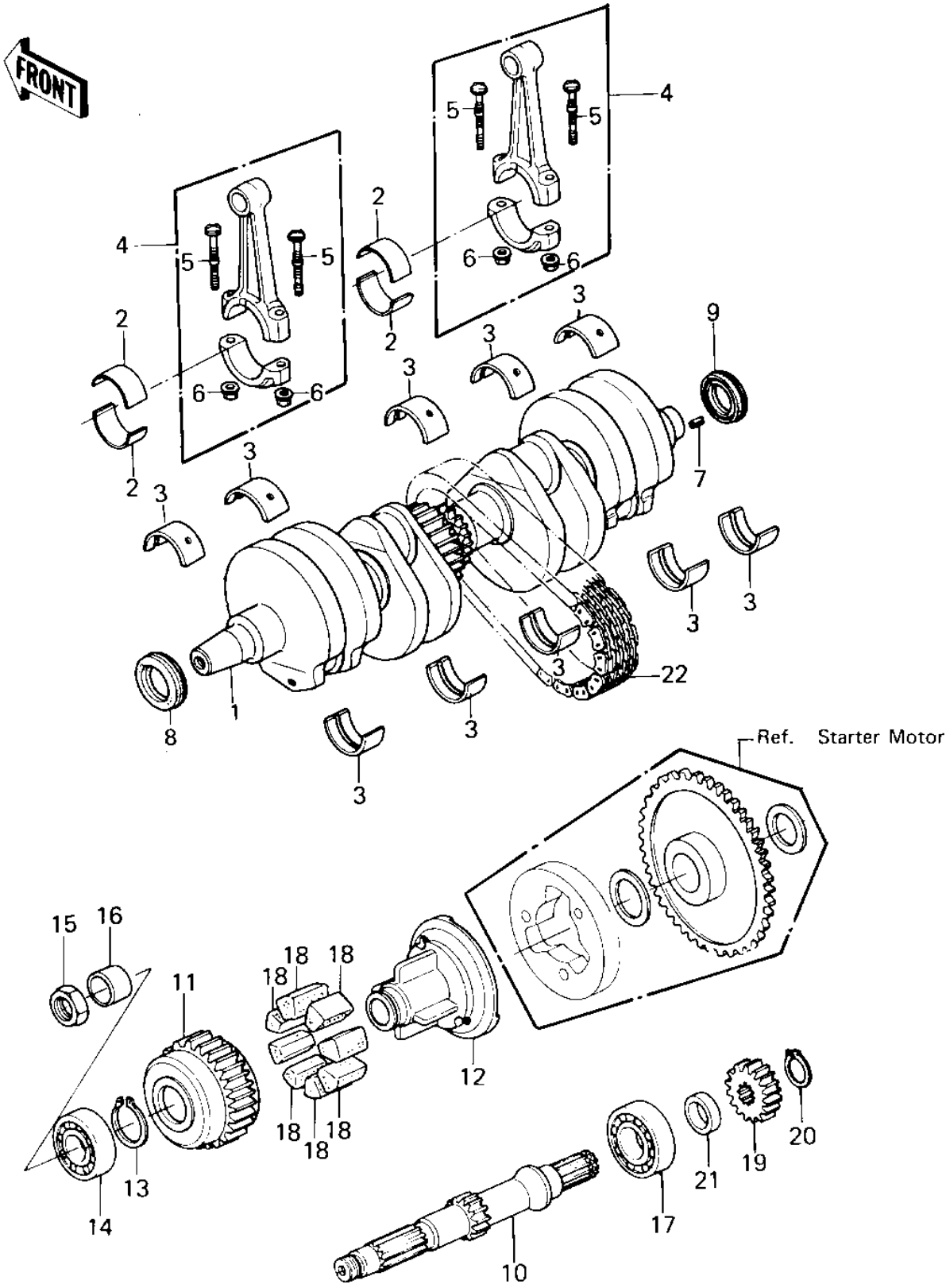

1981 LTD PARTS LIST

CRANKSHAFT/SECONDARY SHAFT ('80-'81 C1/C

ITEM NAME	PART NUMBER	QUANTITY
CRANK SHAFT ASSY (Ref # 1)	13031-1014	1
BUSHING,CONNECTING RO (Ref # 2)	13034-1067	AR
BUSHING,CONNECTING RO (Ref # 2)	13034-1068	AR
BUSHING,CONNECTING RO (Ref # 2)	13034-1069	AR
METAL,BRG,"BROWN"MARK (Ref # 3)	13034-1016	AR
METAL,BRG"BLACK"MARK (Ref # 3)	13034-1017	AR
METAL,BRG,"BLUE"MARK (Ref # 3)	13034-1018	AR
ROD-ASSY-CONNECTING (Ref # 4)	13251-1004-JJ	4
ROD-ASSY-CONNECTING (Ref # 4)	13251-1004-JJ	4
BOLT,CONNECTING ROD (Ref # 5)	92001-1793	8
NUT,CONNECTING ROD (Ref # 6)	92016-060	8
PIN-SPRING,4X8 (Ref # 7)	555A0408	1
OIL SEAL,HSCY 25X36X7 (Ref # 8)	92049-1013	1
OIL SEAL,HSCY25397 (Ref # 9)	92050-081	1
SHAFT,SECONDARY (Ref # 10)	13127-1007	1
COUPLING,OUTER (Ref # 11)	42034-1004	1
COUPLING,INNER (Ref # 12)	42034-1005	1
CIRCLIP 28MM (Ref # 13)	480J2800	1
BEARING BALL #6205 (Ref # 14)	601B6205	1
NUT 18MM (Ref # 15)	92015-019	1
BUSHING,SECONDARY (Ref # 16)	92028-1037	1
BEARING,BALL,#63/22X (Ref # 17)	92045-1017	1
DAMPER RUBBER,COUPLNG (Ref # 18)	92075-1070	8
GEAR,PRIMARY,26T (Ref # 19)	13097-1008	1
CIRCLIP,22MM (Ref # 20)	480J2200	1
COLLAR (Ref # 21)	92027-1438	1
CHAIN,#63-139X50L (Ref # 22)	92057-1011	1