

1983 LTD Belt PARTS DIAGRAM

BATTERY CASE ('81-'83 D2/D3/D4/D5)

F2132-0027

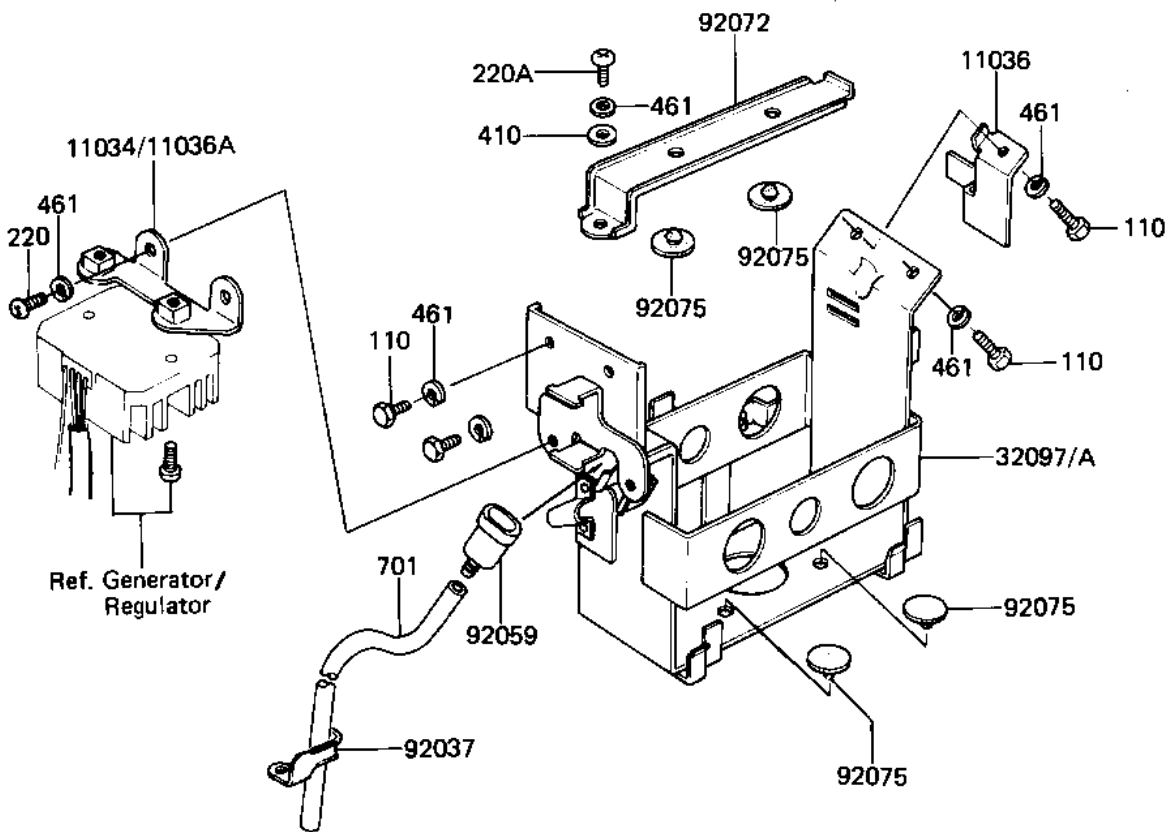
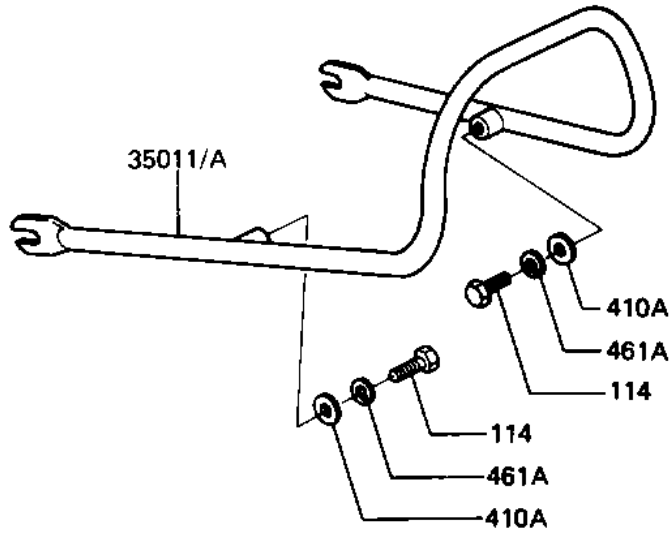

1
1
1
1
2
5
5
5

1983 LTD Belt PARTS LIST

BATTERY CASE ('81-'83 D2/D3/D4/D5)

ITEM NAME	PART NUMBER	QUANTITY
BRACKET-A,FUSE (Ref # 11036)	11036-1001	1
BRACKET-A,REGULATOR (Ref # 11036A)	11036-1105	1
CASE-BATTERY (Ref # 32097A)	32097-1041	1
STAY,RR (Ref # 35011A)	35011-1090	1
CLAMP,BREATHER TUBE (Ref # 92037)	92037-1246	1
CONNECTOR PIPE (Ref # 92059)	92059-101	1
BAND,BATTERY (Ref # 92072)	92072-1034	1
DAMPER,BATTERY CASE (Ref # 92075)	92075-261	6
BOLT-UPSET,6X16 (Ref # 110)	112G0616	4
BOLT-SMALL-UPSET,8X16 (Ref # 114)	115G0816	2
SCREW PAN HEAD 6X12 (Ref # 220)	220B0612	2
SCREW PAN HEAD 6X14 (Ref # 220A)	220B0614	1
WASHER PLAIN 6MM (Ref # 410)	410B0600	1
WASHER PLAIN 8MM (Ref # 410A)	410B0800	2
WASHER SPRING 6MM (Ref # 461)	461F0600	7
WASHER-SPRING,8MM (Ref # 461A)	461F0800	2
TUBE-PVC,6X360 (Ref # 701)	701Q06360	1