

1983 LTD PARTS DIAGRAM

CRANKSHAFT/BALANCER ('81-'83 A2/A3/A4)

E1321-0003

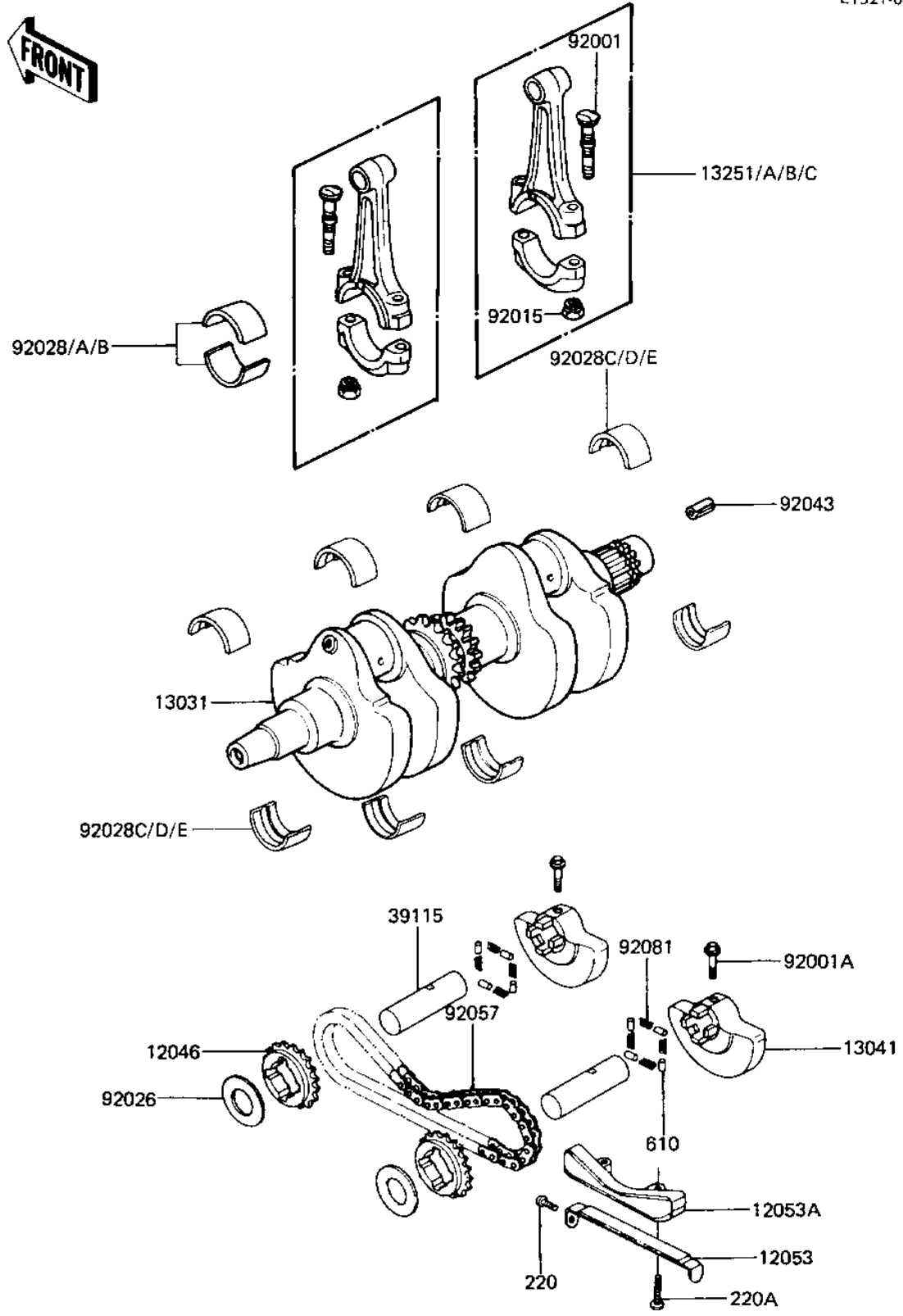

1983 LTD PARTS LIST

CRANKSHAFT/BALANCER ('81-'83 A2/A3/A4)

ITEM NAME	PART NUMBER	QUANTITY
SPROCKET,BALANCER,21T (Ref # 12046)	12046-1003	2
GUIDE,BALANCER,CHAIN (Ref # 12053)	12053-1003	1
GUIDE-CHAIN,BALANCER (Ref # 12053A)	12053-1051	1
CRANKSHAFT ASSY (Ref # 13031)	13031-1037	1
BALANCER (Ref # 13041)	13041-1002	2
CONNECTING ROD ASSY,J (Ref # 13251)	13251-1008-JJ	2
CONNECTING ROD ASSY,J (Ref # 13251A)	13251-1008-JJ	2
CONNECTING ROD ASSY,J (Ref # 13251B)	13251-1008-JJ	2
CONNECTING ROD ASSY,J (Ref # 13251C)	13251-1008-JJ	2
SHAFT,IDLER,BALANCER (Ref # 39115)	39115-1002	2
BOLT,CONNECTING ROD,8 (Ref # 92001)	92001-1887	4
BOLT,6X32 (Ref # 92001A)	92003-229	2
NUT,FLANGED,8MM (Ref # 92015)	92015-1311	4
SPACER,20,3X40X1 (Ref # 92026)	92026-1003	2
BUSHING,CONNECTNG ROD (Ref # 92028)	92028-1097	4
BUSHING,CONNECTNG ROD (Ref # 92028A)	92028-1098	4
BUSHING,CONNECTNG ROD (Ref # 92028B)	92028-1099	4
BUSHING,CRANKSHAFT (Ref # 92028C)	92028-1100	8
BUSHING,CRANKSHAFT (Ref # 92028D)	92028-1101	8
BUSHING,CRANKSHAFT (Ref # 92028E)	92028-1102	8
PIN-SPRING,4X8 (Ref # 92043)	555A0408	1
CHAIN,BALANCER (Ref # 92057)	92057-1007	1
SPRING,BALANCER (Ref # 92081)	92081-135	8
SCREW PAN HEAD 6X8 (Ref # 220)	220B0608	1
SCREW PAN HEAD 6X30 (Ref # 220A)	220B0630	2
PIN DOWEL 4X8 (Ref # 610)	610A0408	8