

1983 LTD PARTS DIAGRAM

GENERATOR/REGULATOR ('81-'83 A2/A3/A4)

E1810-0070

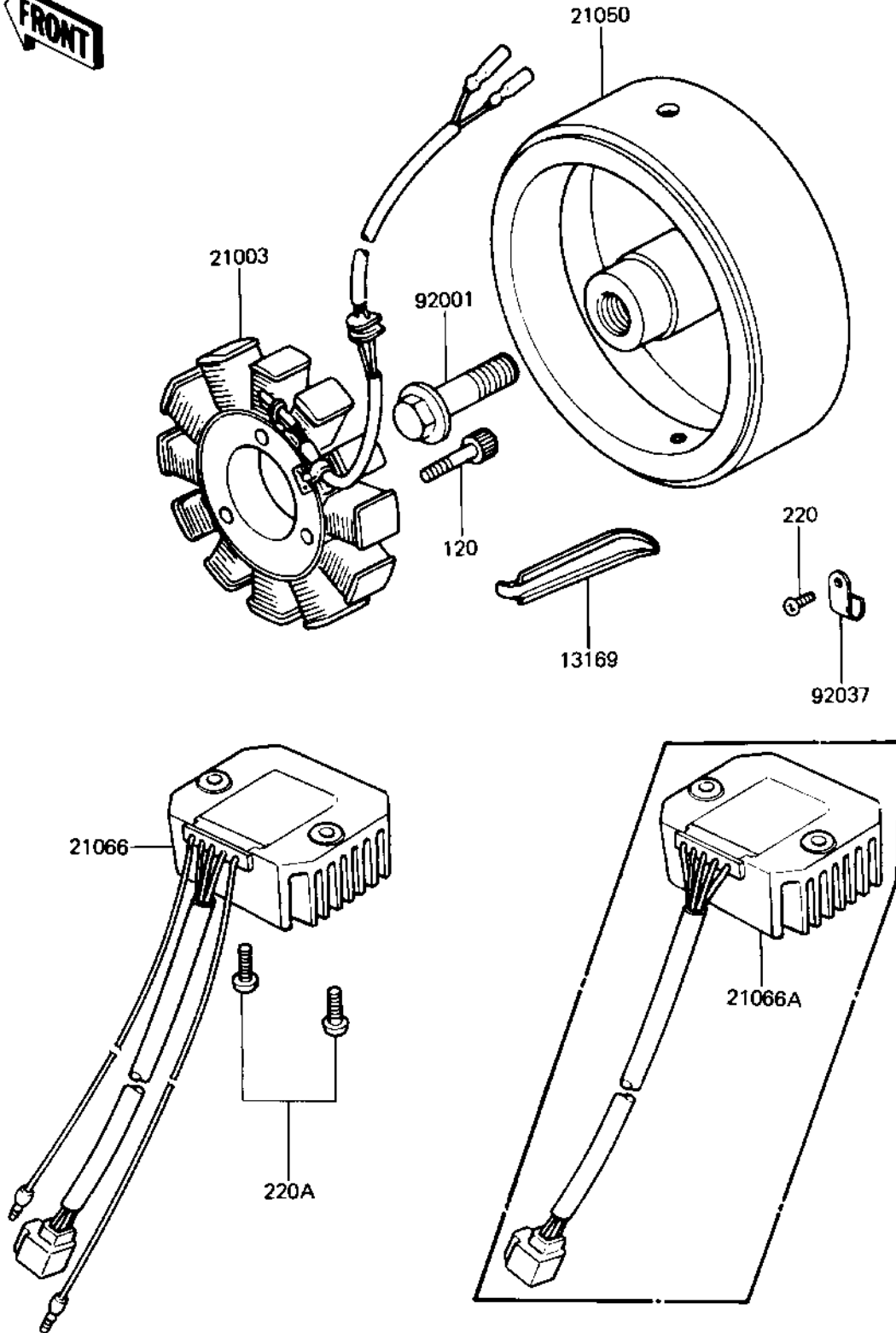

1983 LTD PARTS LIST

GENERATOR/REGULATOR ('81-'83 A2/A3/A4)

ITEM NAME	PART NUMBER	QUANTITY
PLATE,LEAD CLAMP (Ref # 13169)	13169-1008	1
STATOR.ASSY,GENERATER (Ref # 21003)	21003-1009	1
FLYWHEEL (Ref # 21050)	21050-1004	1
REGULATOR-VOLTAGE (Ref # 21066A)	21066-1032	1
BOLT,10X40 (Ref # 92001)	92002-1303	1
CLAMP,WIRING HARNESS (Ref # 92037)	21126-008	1
BOLT,ALLEN,6X28 (Ref # 120)	120P0628	3
SCREW PAN HEAD 6X10 (Ref # 220)	220B0610	1
SCREW PAN HEAD 6X14 (Ref # 220A)	220B0614	2