

1980 KE125 PARTS DIAGRAM

REAR HUB/BRAKE/CHAIN ('80-'81 A7/A8)

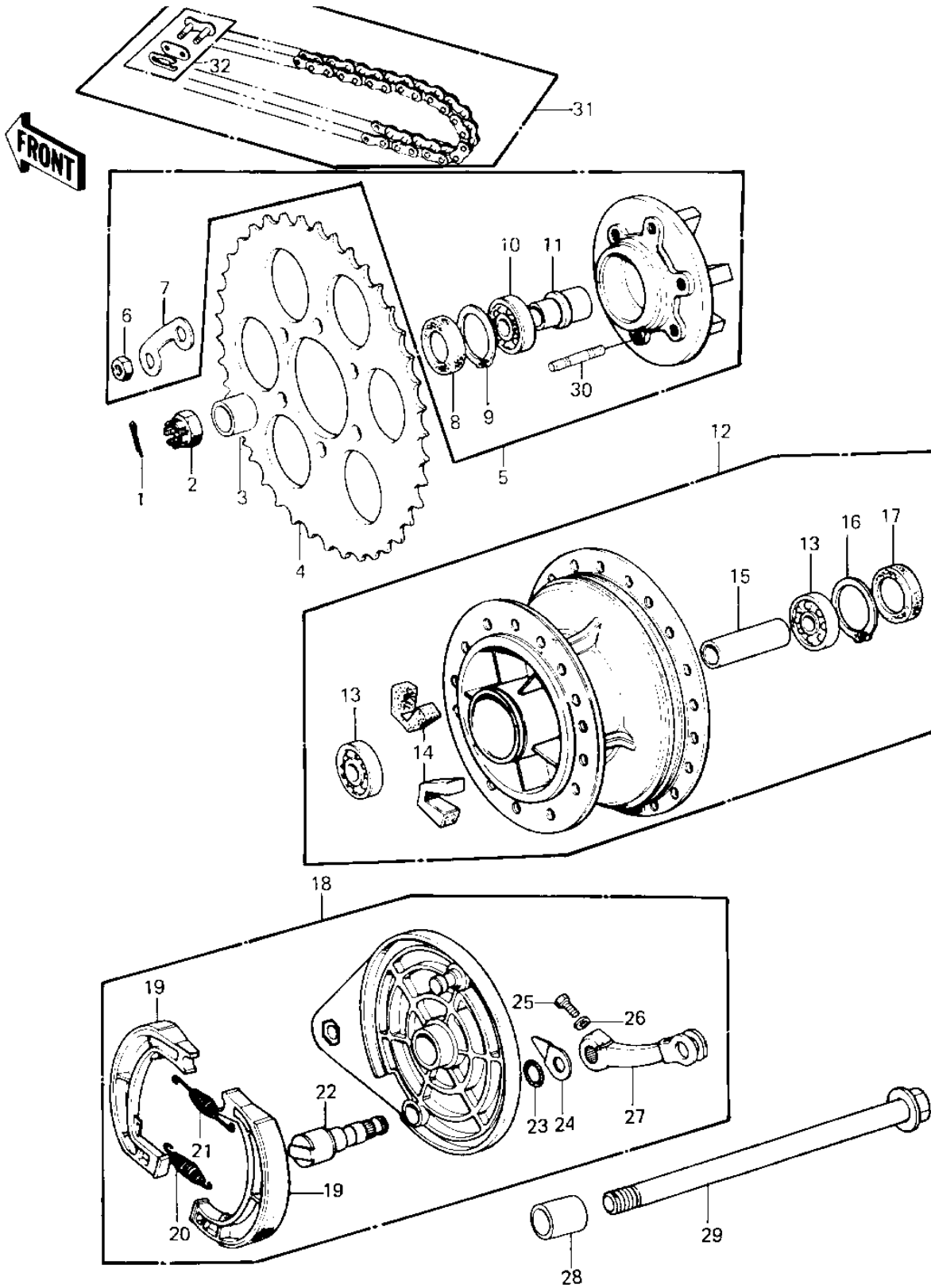

1980 KE125 PARTS LIST

REAR HUB/BRAKE/CHAIN ('80-'81 A7/A8)

ITEM NAME	PART NUMBER	QUANTITY
PIN-COTTER,4.0X35 (Ref # 1)	550D4035	1
NUT CASTLE 14MM (Ref # 2)	92103-006	1
COLLAR,RR BRAKE,L=22 (Ref # 3)	92027-1253	1
REAR SPROCKET.50T (Ref # 4)	42041-146	1
REAR SPROCKET,54T (Ref # 4)	42041-147	(1
COUPLING-ASSY,RR HUB (Ref # 5)	42033-1028	1
NUT,8M/M (Ref # 6)	317B0800	6
WASHER,SPROCKET LOCK (Ref # 7)	92088-019	3
OIL SEAL,RR HUB BRNG (Ref # 8)	92050-060	1
CIRCLIP,42MM (Ref # 9)	92033-1041	1
BEARING BALL #6004 (Ref # 10)	601B6004	1
SLEEVE,RR HUB COUPLNG (Ref # 11)	42036-018	1
DRUM-ASSY,RR BRK (Ref # 12)	41034-1025	1
BEARING BALL #6202 (Ref # 13)	601B6202	2
DAMPER,REAR HUB SHOCK (Ref # 14)	42014-023	6
SPACER,RR HUB BEARING (Ref # 15)	42010-029	1
CIRCLIP,35MM (Ref # 16)	481J3500	1
OIL SEAL,TCY22358 (Ref # 17)	654A223508	1
PANEL-ASY,RR BRK (Ref # 18)	41035-1036	1
SHOE,BRAKE (Ref # 19)	42019-010	2
SPRING,BRAKE SHOE (Ref # 20)	92081-1550	1
SPRING,BRAKE SHOE (Ref # 21)	92081-1766	1
CAM SHAFT,REAR BRAKE (Ref # 22)	42026-025	1
"O" RING,11MM (Ref # 23)	92055-004	1
INDICATOR,FR BRK PNL (Ref # 24)	41085-002	1
BOLT-UPSET (Ref # 25)	112G0622	1
WASHER PLAIN 6MM (Ref # 26)	410B0600	1
LEVER,REAR BRAKE CAM (Ref # 27)	42029-030	1
COLLAR,RR BRAKE,L=25 (Ref # 28)	92027-1254	1

1980 KE125 PARTS LIST

REAR HUB/BRAKE/CHAIN ('80-'81 A7/A8)

ITEM NAME	PART NUMBER	QUANTITY
AXLE,REAR,15X247 (Ref # 29)	41068-1049	1
AXLE,REAR,15X247 (Ref # 29)	41068-1049	1
STUD,8X17 (Ref # 30)	92004-1015	6
DR CHAIN 428X118H (Ref # 31)	92057-030	1
JOINT-CHAIN (Ref # 32)	92058-1015	1