

# 1983 Eddie Lawson Replica PARTS DIAGRAM

VALVES

E1210-0005

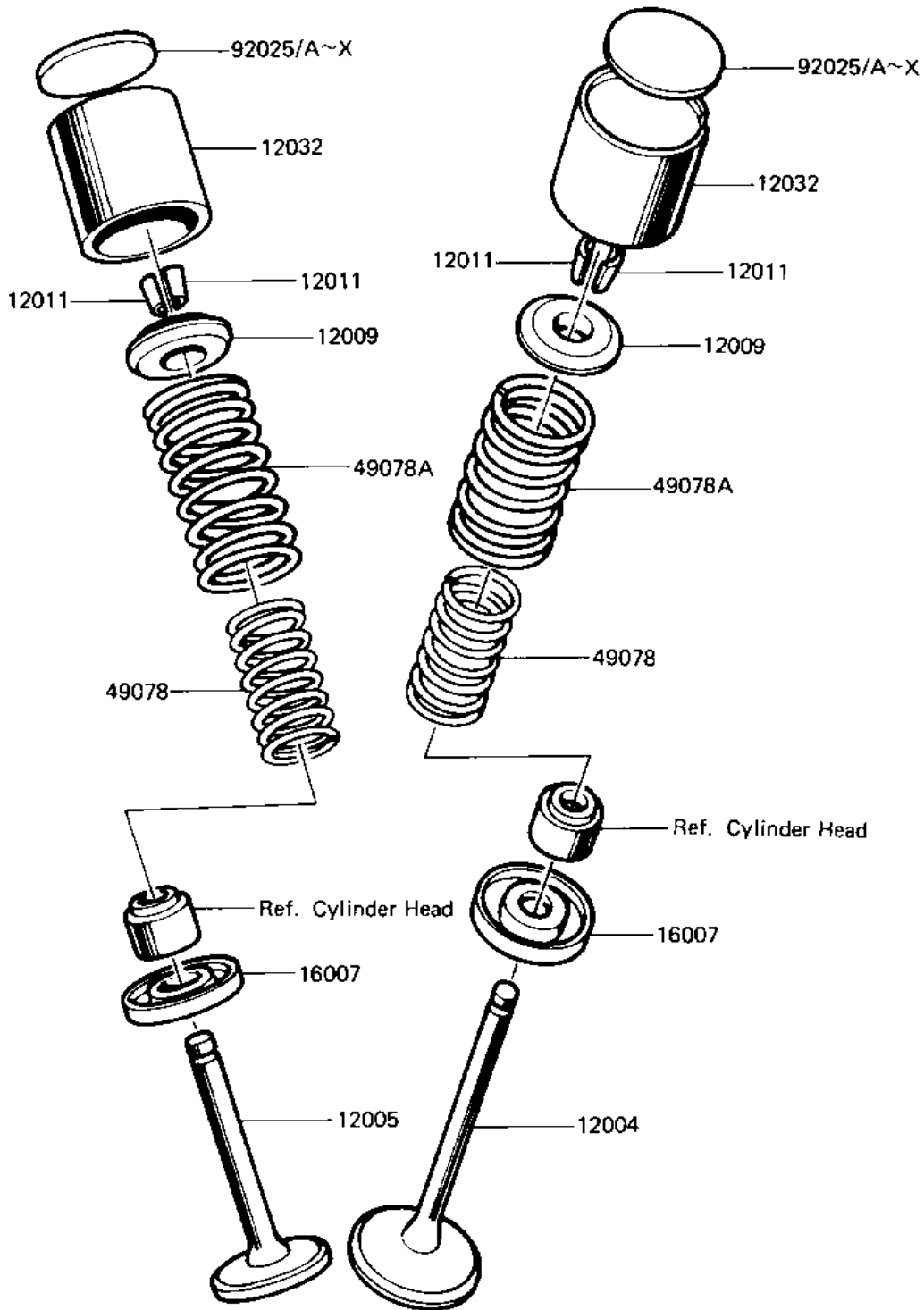

# 1983 Eddie Lawson Replica PARTS LIST

## VALVES

ITEM NAME	PART NUMBER	QUANTITY
VALVE INTAKE (Ref # 12004)	12004-1013	4
VALVE EXHAUST (Ref # 12005)	12005-1011	4
RETAINER,VALVE SPRING (Ref # 12009)	12009-005	8
SPLIT KEEPER (Ref # 12011)	12011-004	16
TAPPET (Ref # 12032)	12032-1002	8
SEAT-SPRING,VALVE (Ref # 16007)	16007-1024	8
SPRING,VALVE,INNER (Ref # 49078)	49078-1001	8
SPRING,VALVE,OUTER (Ref # 49078A)	49078-1002	8
SHIM,TAPPET,2.00T (Ref # 92025)	12037-001	AR
SHIM,TAPPET,2.05T (Ref # 92025A)	12037-002	AR
SHIM,TAPPET,2.10T (Ref # 92025B)	12037-003	AR
SHIM,TAPPET,2.15T (Ref # 92025C)	12037-004	AR
SHIM,TAPPET,2.20T (Ref # 92025D)	12037-005	AR
SHIM,TAPPET,2.25T (Ref # 92025E)	12037-006	AR
SHIM,TAPPET,2.30T (Ref # 92025F)	12037-007	AR
SHIM,TAPPET,2.35T (Ref # 92025G)	12037-008	AR
SHIM,TAPPET,2.40T (Ref # 92025H)	12037-009	AR
SHIM,TAPPET,2.45T (Ref # 92025I)	12037-010	AR
SHIM,TAPPET,2.50T (Ref # 92025J)	12037-011	AR
SHIM,TAPPET,2.55T (Ref # 92025K)	12037-012	AR
SHIM,TAPPET,2.60T (Ref # 92025L)	12037-013	AR
SHIM,TAPPET,2.65T (Ref # 92025M)	12037-014	AR
SHIM,TAPPET,2.70T (Ref # 92025N)	12037-015	AR
SHIM,TAPPET,2.75T (Ref # 92025O)	12037-016	AR
SHIM,TAPPET,2.80T (Ref # 92025P)	12037-017	AR
SHIM,TAPPET,2.85T (Ref # 92025Q)	12037-018	AR
SHIM,TAPPET,2.90T (Ref # 92025R)	12037-019	AR
SHIM,TAPPET,2.95T (Ref # 92025S)	12037-020	AR
SHIM,TAPPET,3.00T (Ref # 92025T)	12037-021	AR

# 1983 Eddie Lawson Replica PARTS LIST

## VALVES

ITEM NAME	PART NUMBER	QUANTITY
SHIM,TAPPET,3.05T (Ref # 92025U)	12037-022	AR
SHIM,TAPPET,3.10T (Ref # 92025V)	12037-023	AR
SHIM,TAPPET,3.15T (Ref # 92025W)	12037-024	AR
SHIM,TAPPET 3.20T (Ref # 92025X)	12037-025	AR