

1982 Eddie Lawson Replica PARTS DIAGRAM

OIL COOLER

E3034-0004

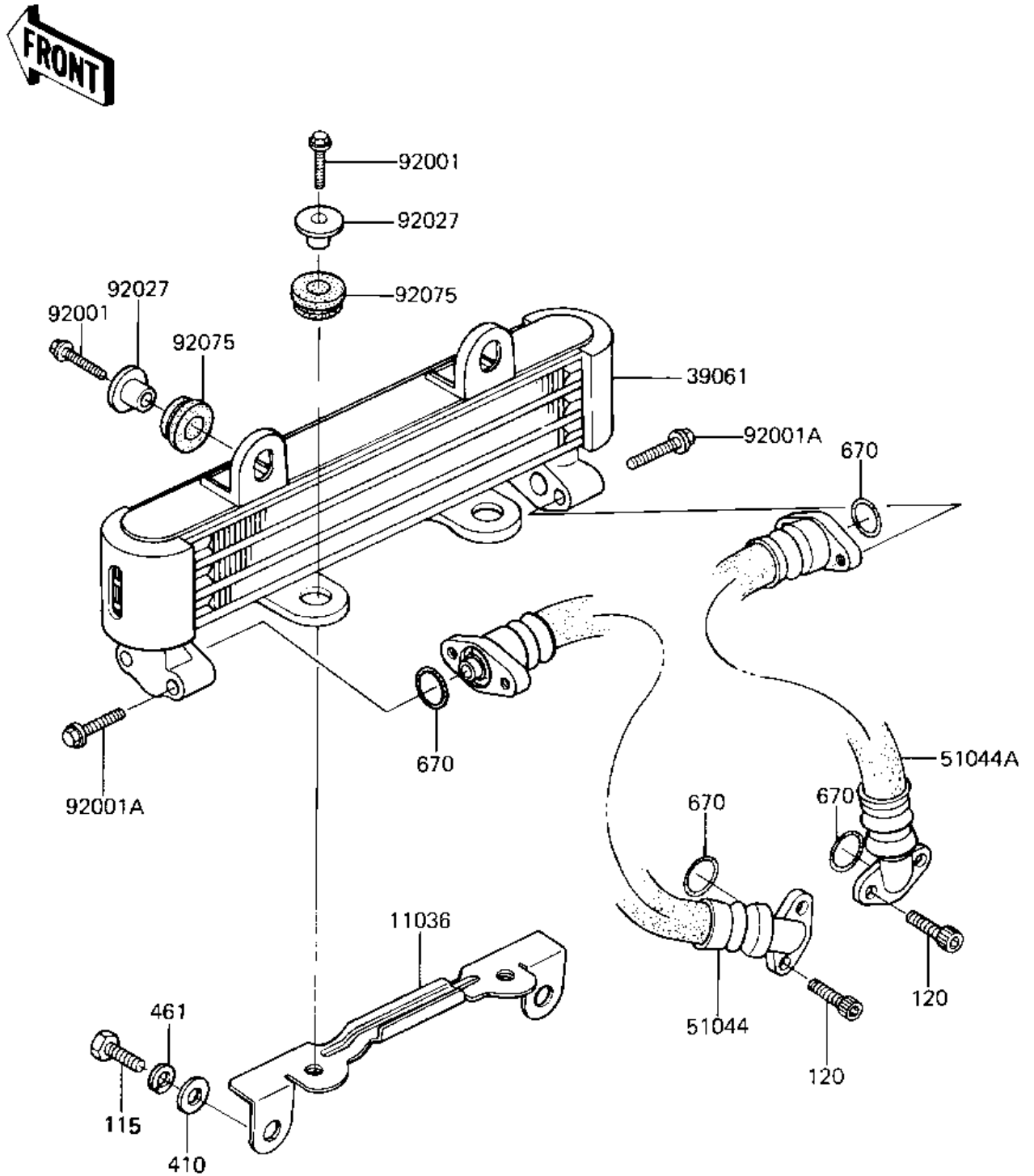

1982 Eddie Lawson Replica PARTS LIST

OIL COOLER

ITEM NAME	PART NUMBER	QUANTITY
BRACKET-A,OIL COOLER (Ref # 11036)	11036-1508	1
EXCHANGER-ASSY-HEAT (Ref # 39061)	39061-1006-10	1
TUBE-ASSY,OIL COOLER (Ref # 51044)	51044-1030	1
TUBE-ASSY,OIL COOLER (Ref # 51044A)	51044-1031	1
BOLT-FLANGED,6X20 (Ref # 92001)	130J0620	4
BOLT,FLANGED,6X25,BLK (Ref # 92001A)	92001-1467	4
COLLAR,FLANGED,L=12.1 (Ref # 92027)	92027-1651	4
DAMPER RUBBER (Ref # 92075)	92075-277	4
BOLT-SMALL,8X16,BLACK (Ref # 115)	115C0816	2
BOLT-SOCKET,6X16,BLAC (Ref # 120)	120S0616	4
WASHER,PLAIN,8MM (Ref # 410)	92022-1554	2
WASHER-SPRING,8MM,BLA (Ref # 461)	461K0800	2
O RING,14MM (Ref # 670)	670D2014	4