

1983 KLT200 PARTS DIAGRAM

IGNITION/GENERATOR/REGULATOR

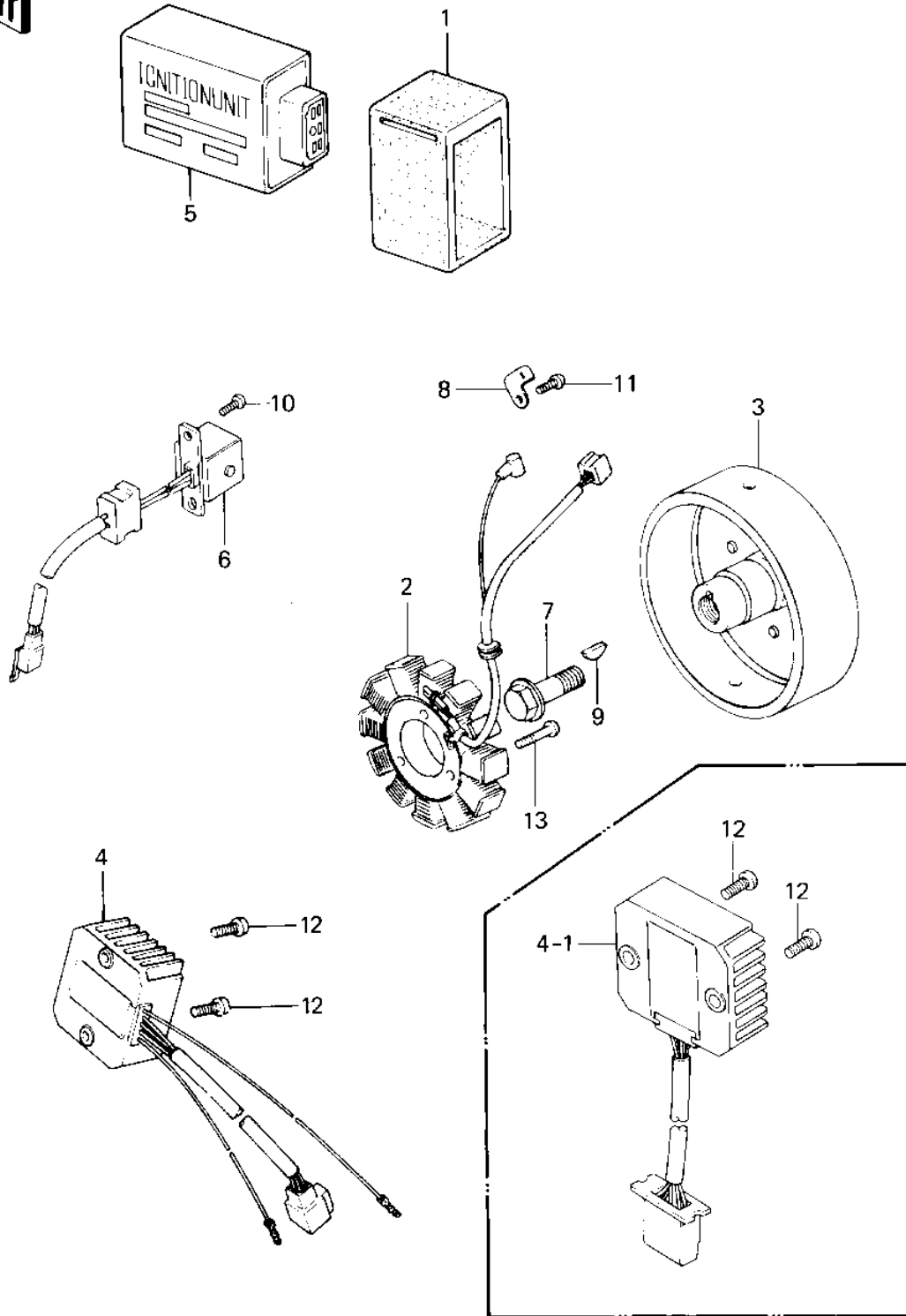

1983 KLT200 PARTS LIST

IGNITION/GENERATOR/REGULATOR

ITEM NAME	PART NUMBER	QUANTITY
HOLDER (Ref # 1)	13091-1095	1
STATOR ASSY (Ref # 2)	21003-1002	1
ROTOR (Ref # 3)	21007-1107	1
REGULATOR,VOLTAGE (Ref # 4)	21066-1014	1
REGULATOR-VOLTAGE (Ref # 4-1)	21066-1032	1
IGNITER (Ref # 5)	21119-1193	1
COIL-PULSING (Ref # 6)	59026-1018	1
BOLT,10X40 (Ref # 7)	92001-1201	1
CLAMP (Ref # 8)	92037-194	1
WOODRUFF KEY (Ref # 9)	92038-001	1
SCREW PAN HEAD 5X8 (Ref # 10)	220B0508	2
SCREW PAN HEAD 6X8 (Ref # 11)	220B0608	1
SCREW PAN HEAD 6X14 (Ref # 12)	220B0614	2
SCREW PAN HEAD 6X20 (Ref # 13)	220B0620	3