

1984 KLR250 PARTS DIAGRAM

CYLINDER HEAD/COVERS

E1111-0107

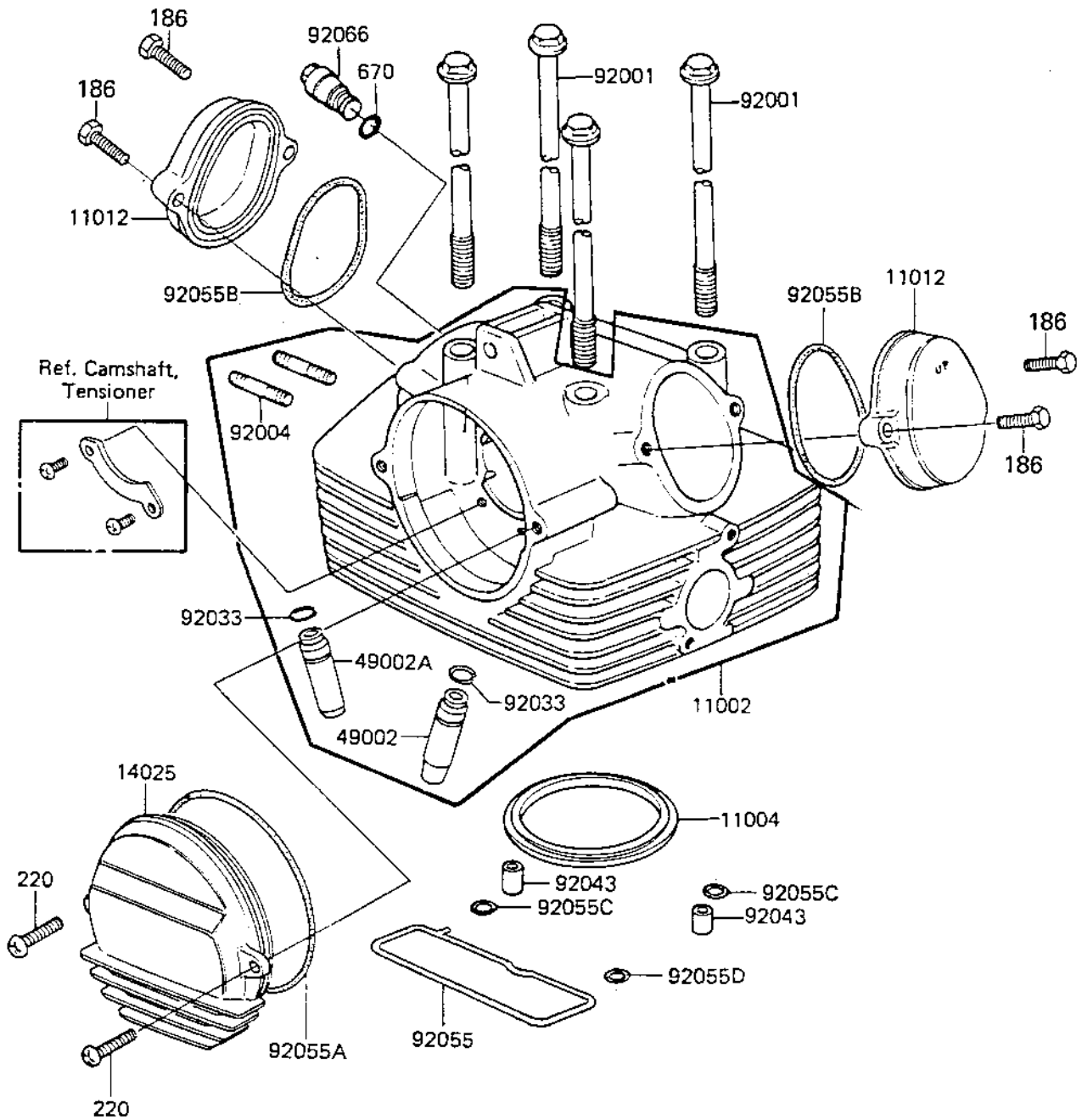

1984 KLR250 PARTS LIST

CYLINDER HEAD/COVERS

ITEM NAME	PART NUMBER	QUANTITY
HEAD-ASSY-CYLINDER (Ref # 11002)	11002-5028	1
GASKET,CYLINDER HEAD (Ref # 11004)	11004-1002	1
CAP,ROCKER,F.BLACK (Ref # 11012)	11012-1270	2
COVER,CAMSHAFT,F.BLAC (Ref # 14025)	14025-1549	1
GUIDE,INLET VALVE (Ref # 49002)	12013-009	1
GUIDE,EXHAUST VALVE (Ref # 49002A)	49002-1002	1
BOLT,8X233 (Ref # 92001)	92003-220	4
STUD,8X30 (Ref # 92004)	92004-1069	2
CIRCLIP-VALVE (Ref # 92033)	92036-023	2
PIN,DOWEL,10X8.2X14 (Ref # 92043)	92043-1037	2
"O" RING (Ref # 92055)	92055-105	1
"O" RING,99M/M (Ref # 92055A)	92055-107	1
"O" RING,53.5MM (Ref # 92055B)	92055-112	2
RING-O,10MM (Ref # 92055C)	92055-1149	2
O RING,10MM (Ref # 92055D)	92055-1150	1
PLUG,TACHOMETER GEAR (Ref # 92066)	92066-060	1
BOLT-UPSET-WP (Ref # 186)	186G0625	4
SCREW PAN HEAD 6X16 (Ref # 220)	220B0616	2
"O" RING,10MM (Ref # 670)	670D1510	1