

1986 Eliminator PARTS DIAGRAM

CRANKSHAFT

E1321-0076

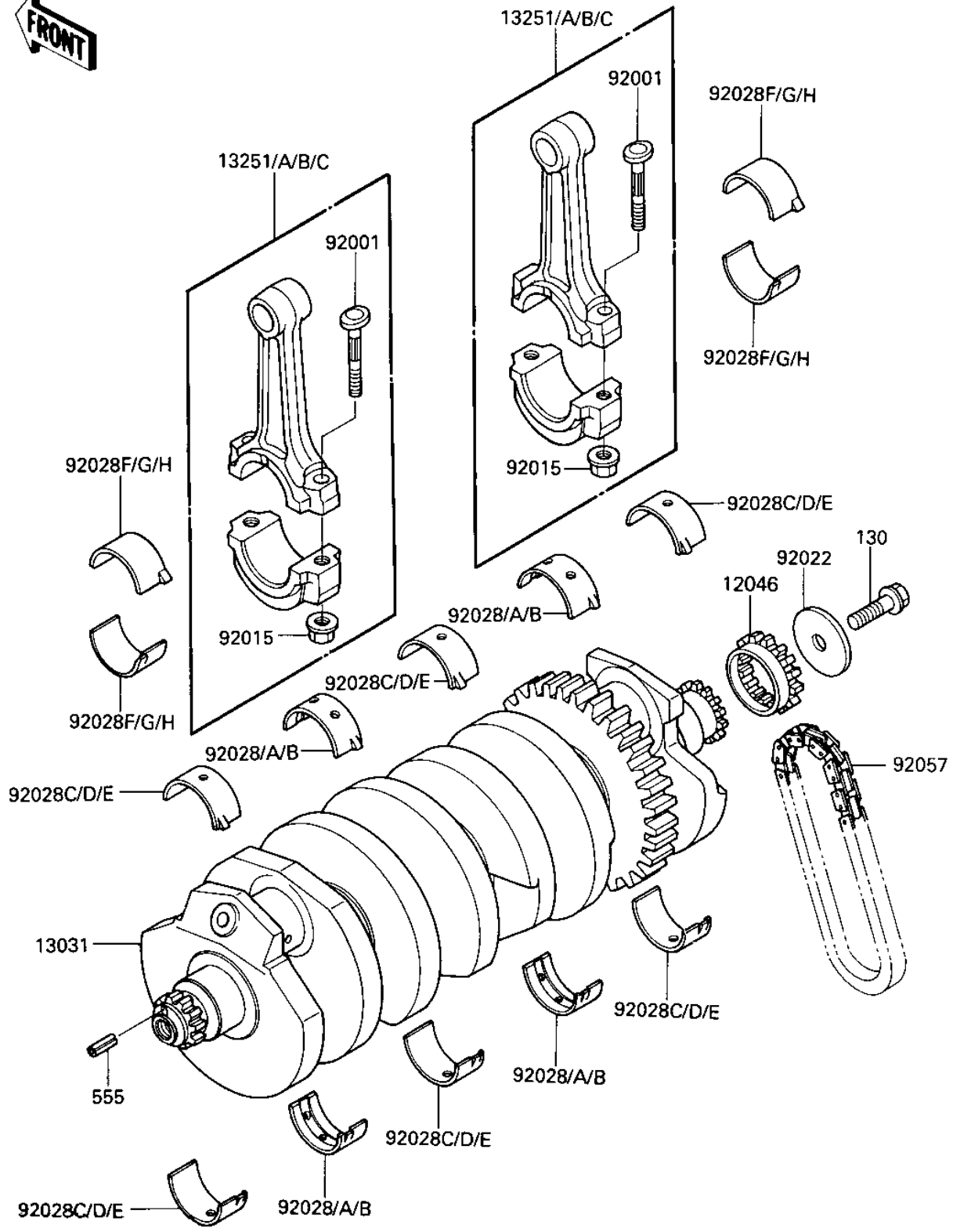

1986 Eliminator PARTS LIST

CRANKSHAFT

ITEM NAME	PART NUMBER	QUANTITY
SPROCKET,21T (Ref # 12046)	12046-1067	1
CRANKSHAFT-COMP (Ref # 13031)	13031-1332	1
ROD-ASSY-CONNECTING,J (Ref # 13251)	13251-1052-JJ	4
ROD-ASSY-CONNECTING,J (Ref # 13251A)	13251-1052-JJ	4
ROD-ASSY-CONNECTING,J (Ref # 13251B)	13251-1052-JJ	4
ROD-ASSY-CONNECTING,J (Ref # 13251C)	13251-1052-JJ	4
BOLT,CONNECTING ROD,8 (Ref # 92001)	92001-1887	8
NUT,FLANGED,8MM (Ref # 92015)	92015-1311	8
WASHER,8.5X36X4 (Ref # 92022)	92022-1633	1
BUSHING,CRANKSHAFT (Ref # 92028)	92028-1100	AR
BUSHING,CRANKSHAFT (Ref # 92028A)	92028-1101	AR
BUSHING,CRANKSHAFT (Ref # 92028B)	92028-1102	AR
BUSHING,CRANKSHAFT,BL (Ref # 92028C)	92028-1272	AR
BUSHING,CRANKSHAFT,BL (Ref # 92028D)	92028-1273	AR
BUSHING,CRANKSHAFT,BR (Ref # 92028E)	92028-1274	AR
BUSHING,CONNECTING RO (Ref # 92028F)	92028-1321	AR
BUSHING,CONNECTING RO (Ref # 92028G)	92028-1322	AR
BUSHING,CONNECTING RO (Ref # 92028H)	92028-1323	AR
CHAIN (Ref # 92057)	92057-1292	1
BOLT-FLANGED,8X25 (Ref # 130)	130G0825	1
PIN-SPRING (Ref # 555)	555A0410	1