

1986 Eliminator PARTS DIAGRAM

FRONT BEVEL GEARS

E3131-0011

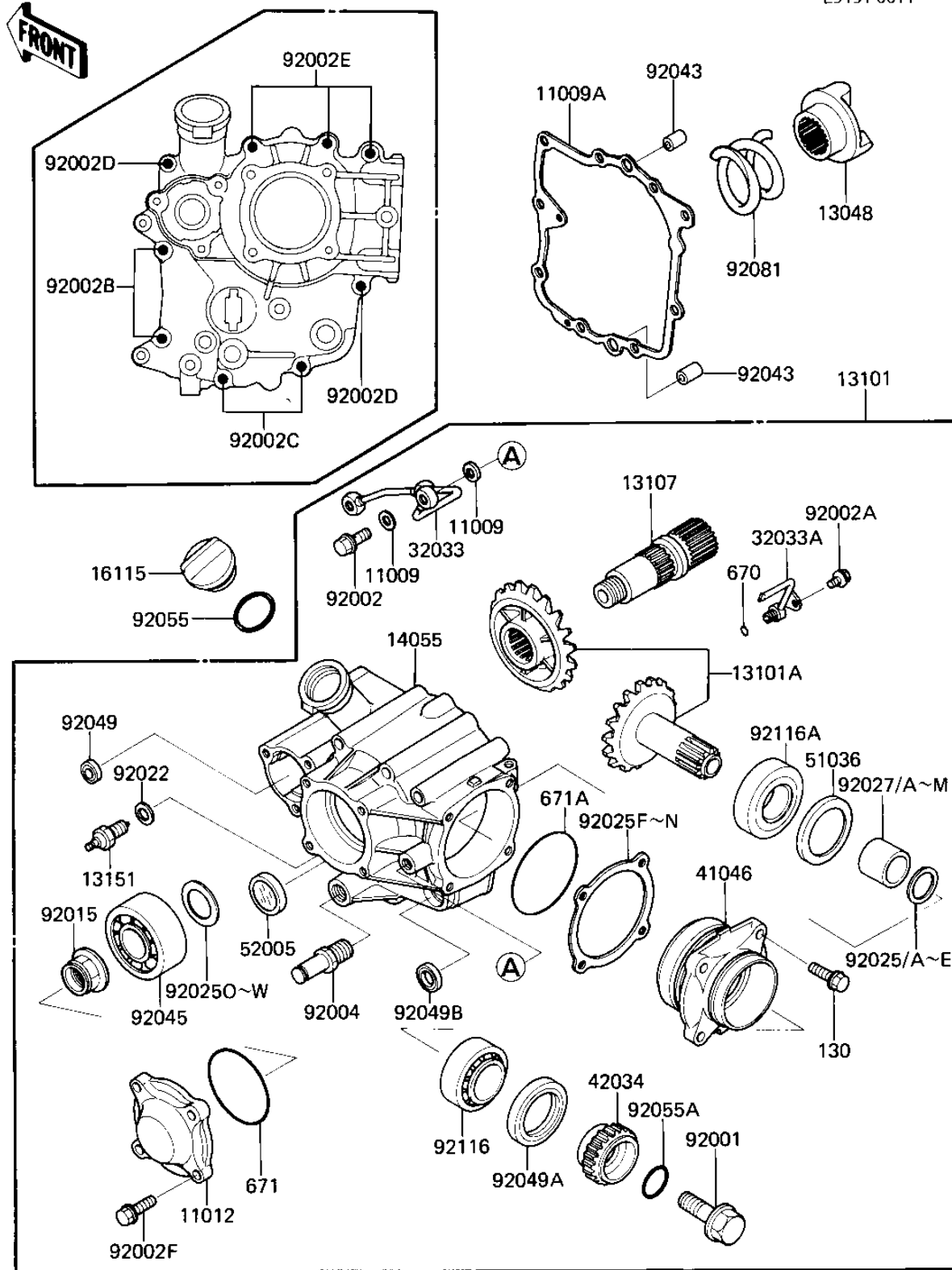

1986 Eliminator PARTS LIST

FRONT BEVEL GEARS

ITEM NAME	PART NUMBER	QUANTITY
GASKET,OIL PIPE,8.2X1 (Ref # 11009)	11009-1344	6
GASKET,BEVEL GEAR CAS (Ref # 11009A)	11009-1532	1
CAP,BEARING (Ref # 11012)	11012-1477	1
CAM,DAMPER (Ref # 13048)	13048-1005	1
GEAR-ASSY (Ref # 13101)	13101-1113	1
GEAR-ASSY,FRONT BEVEL (Ref # 13101A)	13101-5050	1
SHAFT,BEVEL GEAR,FR (Ref # 13107)	13107-1190	1
SWITCH,NEUTRAL (Ref # 13151)	13151-1007	1
CASE-GEAR,BEVEL,FR (Ref # 14055)	14055-1065	1
CAP-OIL FILLER (Ref # 16115)	16115-1009	1
PIPE,OIL (Ref # 32033)	32033-1706	1
PIPE,OIL (Ref # 32033A)	32033-1707	1
HOUSING-BEARING (Ref # 41046)	41046-1067	1
COUPLING,FR DRIVEN (Ref # 42034)	42034-1091	1
CUP (Ref # 51036)	51036-1002	1
GAUGE,OIL LEVEL (Ref # 52005)	52005-1057	1
BOLT,12X42 (Ref # 92001)	92001-1169	1
BOLT,BANJO,8X20 (Ref # 92002)	92002-1429	3
BOLT,6X10 (Ref # 92002A)	92002-1449	1
BOLT,6X25 (Ref # 92002B)	92002-1582	2
BOLT,6X50 (Ref # 92002C)	92002-1583	2
BOLT,6X60 (Ref # 92002D)	92002-1584	2
BOLT,6X105 (Ref # 92002E)	92002-1585	3
BOLT (Ref # 92002F)	92002-1612	4
STUD (Ref # 92004)	92004-1109	1
NUT (Ref # 92015)	92015-1543	1
GASKET CHECK VALVE (Ref # 92022)	92065-058	1
SHIM,1.70T (Ref # 92025)	92025-1072	AR
SHIM,1.72T (Ref # 92025A)	92025-1073	AR

1986 Eliminator PARTS LIST

FRONT BEVEL GEARS

ITEM NAME	PART NUMBER	QUANTITY
SHIM,1.74T (Ref # 92025B)	92025-1074	AR
SHIM,1.76T (Ref # 92025C)	92025-1075	AR
SHIM,1.78T (Ref # 92025D)	92025-1076	AR
SHIM,1.80T (Ref # 92025E)	92025-1077	AR
SHIM,T=0.1 (Ref # 92025F)	92025-1606	AR
SHIM,T=0.15 (Ref # 92025G)	92025-1607	AR
SHIM,T=0.5 (Ref # 92025H)	92025-1608	AR
SHIM,T=0.6 (Ref # 92025I)	92025-1609	AR
SHIM,T=0.7 (Ref # 92025J)	92025-1610	AR
SHIM,T=0.8 (Ref # 92025K)	92025-1611	AR
SHIM,T=0.9 (Ref # 92025L)	92025-1612	AR
SHIM,T=1.0 (Ref # 92025M)	92025-1613	AR
SHIM,T=1.2 (Ref # 92025N)	92025-1614	AR
SHIM,25.3X36X0.15 (Ref # 92025O)	92025-1688	AR
SHIM,25.3X36X0.50 (Ref # 92025P)	92025-1689	AR
SHIM,25.3X36X0.60 (Ref # 92025Q)	92025-1690	AR
SHIM,25.3X36X0.70 (Ref # 92025R)	92025-1691	AR
SHIM,25.3X36X0.80 (Ref # 92025S)	92025-1692	AR
SHIM,25.3X36X0.90 (Ref # 92025T)	92025-1693	AR
SHIM,25.3X36X1.0 (Ref # 92025U)	92025-1694	AR
SHIM,25.3X36X1.1 (Ref # 92025V)	92025-1695	AR
SHIM,25.3X36X1.2 (Ref # 92025W)	92025-1696	AR
COLLAR,L=22.8M/M (Ref # 92027)	92027-1152	AR
COLLAR,L=22.9M/M (Ref # 92027A)	92027-1153	AR
COLLAR,L=23.0M/M (Ref # 92027B)	92027-1154	AR
COLLAR,L=23.1M/M (Ref # 92027C)	92027-1155	AR
COLLAR,L=23.2M/M (Ref # 92027D)	92027-1156	AR
COLLAR,L=23.3M/M (Ref # 92027E)	92027-1157	AR
COLLAR,L=23.4M/M (Ref # 92027F)	92027-1158	AR

1986 Eliminator PARTS LIST

FRONT BEVEL GEARS

ITEM NAME	PART NUMBER	QUANTITY
COLLAR,L=23.5M/M (Ref # 92027G)	92027-1159	AR
COLLAR,L=23.6M/M (Ref # 92027H)	92027-1160	AR
COLLAR,L=23.7M/M (Ref # 92027I)	92027-1161	AR
COLLAR,L=23.8M/M (Ref # 92027J)	92027-1162	AR
COLLAR,L=23.9M/M (Ref # 92027K)	92027-1163	AR
COLLAR,L=24.0M/M (Ref # 92027L)	92027-1164	AR
COLLAR,L=24.1M/M (Ref # 92027M)	92027-1165	AR
PIN-DOWEL (Ref # 92043)	92042-007	2
BEARING-BALL (Ref # 92045)	92045-1160	1
OIL SEAL,SD-8187 (Ref # 92049)	92049-1017	1
OIL SEAL,TC35527 (Ref # 92049A)	92049-1038	1
OIL SEAL,TB13225.5 (Ref # 92049B)	92051-005	1
"O" RING,31MM (Ref # 92055)	92055-049	1
"O" RING,I.D=18.64MM (Ref # 92055A)	92055-1044	1
SPRING,CAM DAMPER (Ref # 92081)	92081-1859	1
BEARING (Ref # 92116)	92116-1003	1
BRG,ROLLER,4T-30305 (Ref # 92116A)	92116-1006	1
BOLT-FLANGED,6X25,BLA (Ref # 130)	130S0625	4
"O" RING,6M/M (Ref # 670)	670B1506	1
"O" RING,65MM (Ref # 671)	671B2565	1
"O" RING,70MM (Ref # 671A)	671B2570	1