

1985 KDX200 PARTS DIAGRAM

KICKSTARTER MECHANISM

E1340-0038

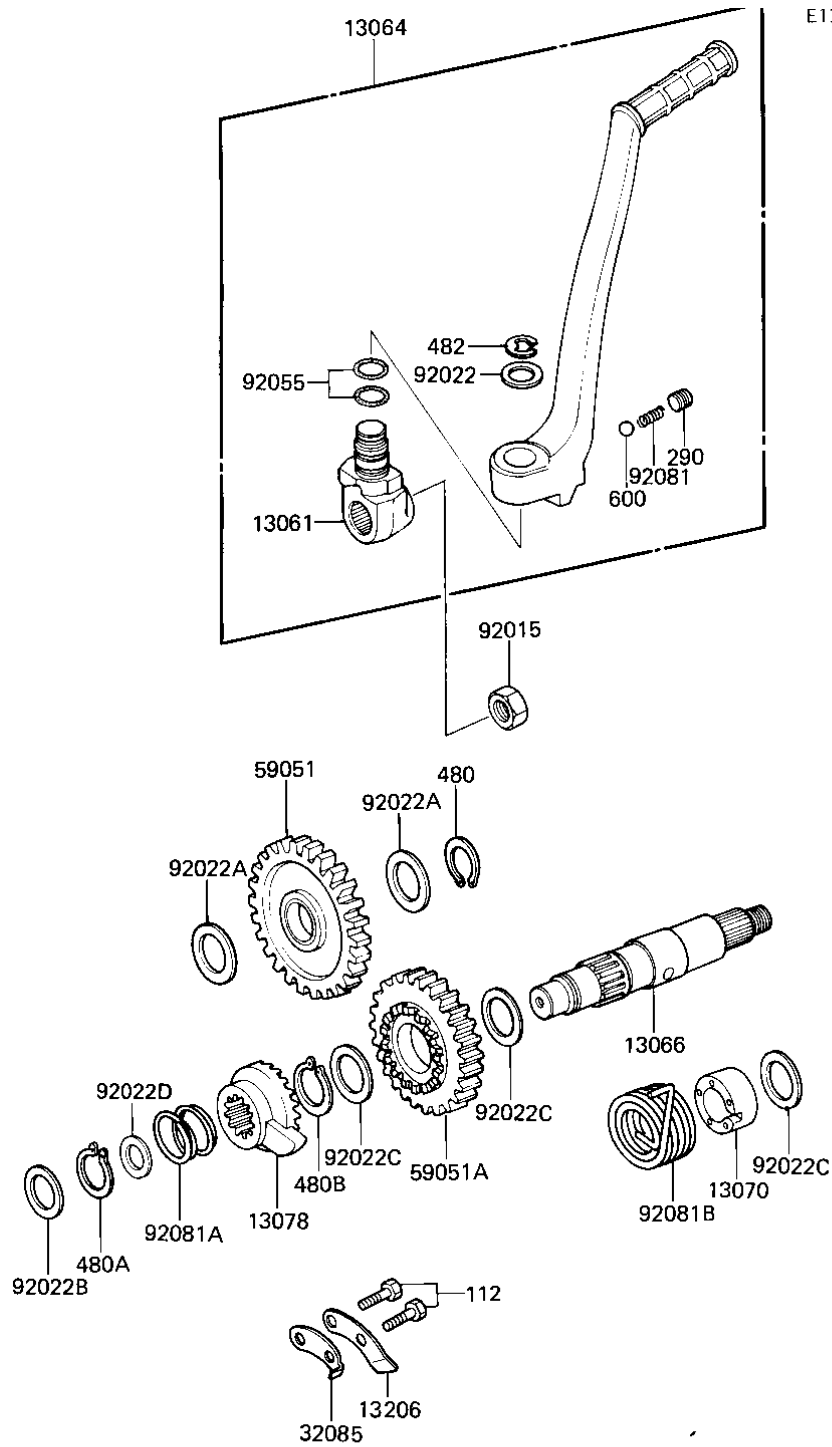

1985 KDX200 PARTS LIST

KICKSTARTER MECHANISM

ITEM NAME	PART NUMBER	QUANTITY
BOSS,KICK PEDAL (Ref # 13061)	13061-1067	1
LEVER-ASSY-KICK,PEDAL (Ref # 13064)	13064-1128	1
SHAFT-KICK (Ref # 13066)	13066-1026	1
GUIDE,KICK SPRING (Ref # 13070)	13070-1063	1
RATCHET (Ref # 13078)	13078-1061	1
GUIDE-KICK (Ref # 13206)	13206-1059	1
STOPPER,KICKSTARTER (Ref # 32085)	32085-1016	1
GEAR-SPUR,KICK,30T (Ref # 59051)	59051-1041	1
GEAR-SPUR,KICKSTARTER (Ref # 59051A)	59051-1050	1
NUT,12MM (Ref # 92015)	92015-1001	1
WASHER,PLAIN (Ref # 92022)	92022-1019	1
WASHER,PLAIN (Ref # 92022A)	92022-1045	2
WASHER,PLAIN (Ref # 92022B)	92022-269	1
WASHER,PLAIN (Ref # 92022C)	92022-271	3
WASHER,PLAIN (Ref # 92022D)	92022-315	1
"O" RING (Ref # 92055)	92055-061	2
SPRING KICK PEDAL (Ref # 92081)	92081-020	1
SPRING,RATCHET (Ref # 92081A)	92081-122	1
SPRING,KICKSTARTER (Ref # 92081B)	92081-1515	1
BOLT-UPSET (Ref # 112)	112G0618	2
SCREW,8X8 (Ref # 290)	290Q0808	1
CIRCLIP 15MM (Ref # 480)	480J1500	1
CIRCLIP 16MM (Ref # 480A)	480J1600	1
CIRCLIP 18MM (Ref # 480B)	480J1800	1
CIR CLIP (Ref # 482)	482K0100	1
BALL STEEL 1/4' (Ref # 600)	600A0800	1