

1985 KDX200 PARTS DIAGRAM

GEAR CHANGE MECHANISM

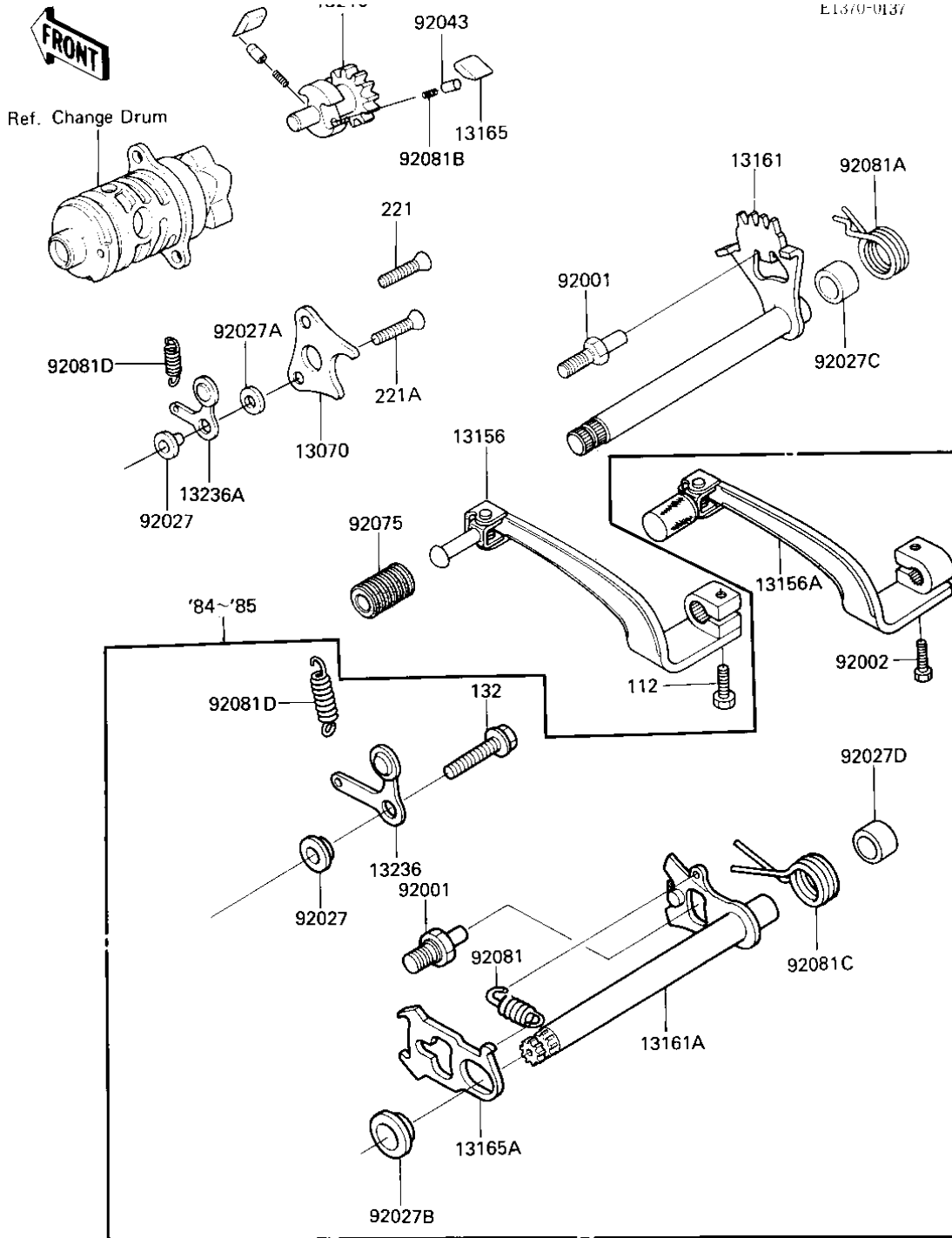

1985 KDX200 PARTS LIST

GEAR CHANGE MECHANISM

ITEM NAME	PART NUMBER	QUANTITY
LEVER-CHANGE,PEDAL (Ref # 13156A)	13156-1164	1
LEVER-COMP-CHANGE SHA (Ref # 13161A)	13161-1101	1
PAWL,CHANGE LEVER (Ref # 13165A)	13165-1119	1
BOLT,RETURN SPRING (Ref # 92001)	92001-1401	1
BOLT-FLANGED,6X25 (Ref # 92002)	130P0625	1
COLLAR (Ref # 92027)	92027-1248	1
COLLAR,CHANGE SHAFT,L (Ref # 92027B)	92027-1512	1
COLLAR,L=10.6 (Ref # 92027D)	92027-1916	1
SPRING-CHANGE LEVER (Ref # 92081)	92081-076	1
SPRING,CHANGE SHAFT R (Ref # 92081C)	92081-1716	1
SPRING,CHNG DRUM LEVER (Ref # 92081D)	92083-012	1
BOLT-FLANGED-SMALL (Ref # 132)	132G0616	1