

# 1986 KLR250 PARTS DIAGRAM

FRONT HUB

F2230-0121

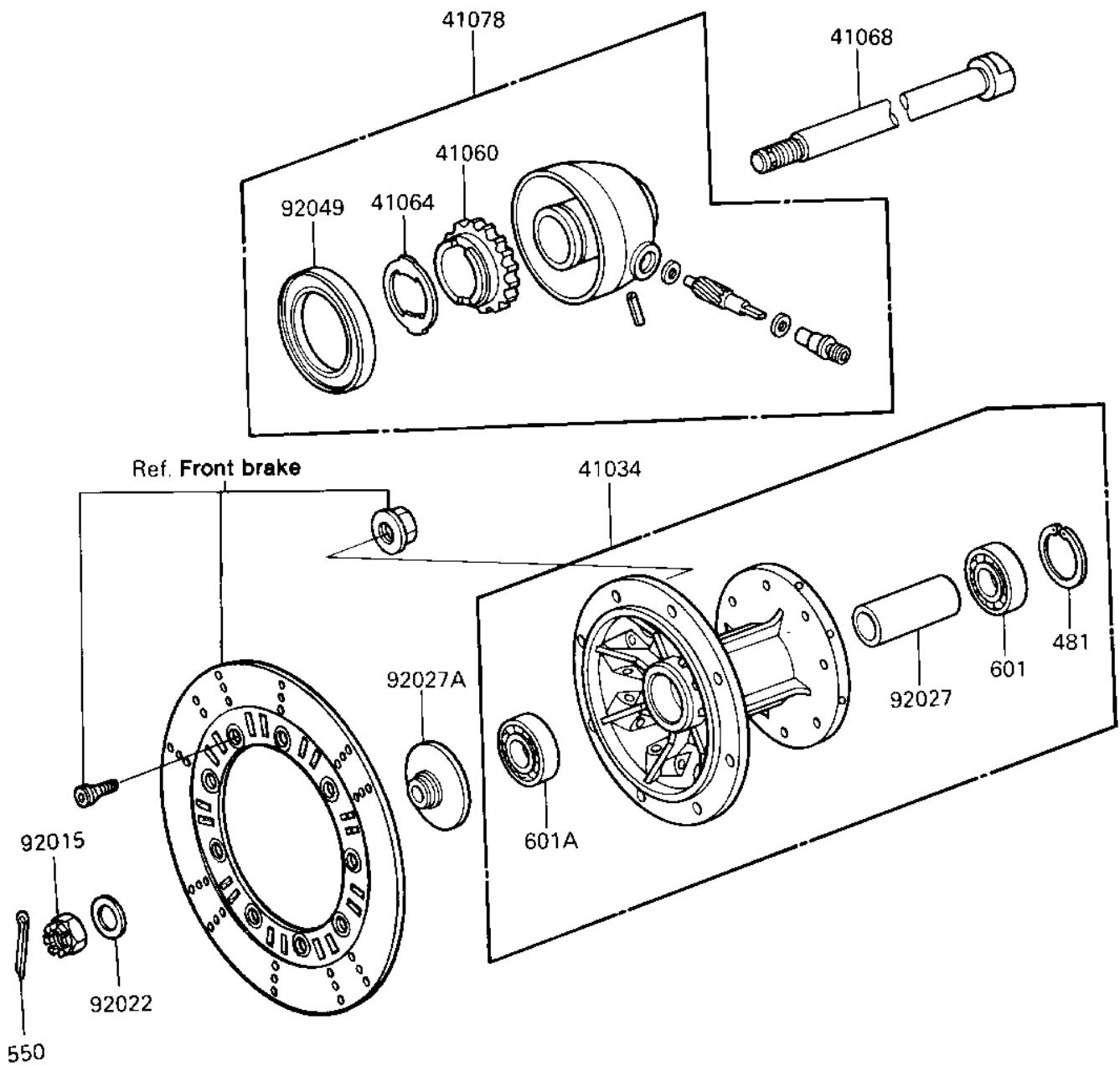

# 1986 KLR250 PARTS LIST

## FRONT HUB

ITEM NAME	PART NUMBER	QUANTITY
DRUM-ASSY,FRONT BRAKE (Ref # 41034)	41034-1128	1
GEAR-METER SCREW,24T (Ref # 41060)	41060-1101	1
RECEIVER-SPEEDOMETER (Ref # 41064)	41064-1051	1
AXLE,FR (Ref # 41068)	41068-1236	1
CASE-ASSY-METER GEAR (Ref # 41078)	41078-1051	1
NUT,14MM (Ref # 92015)	42045-020	1
WASHER,15.5X28X2 (Ref # 92022)	92022-1550	1
COLLAR,FRONT BRAKE DR (Ref # 92027)	92027-1683	1
COLLAR,FRONT AXLE (Ref # 92027A)	92027-1864	1
SEAL-OIL,METER GEAR C (Ref # 92049)	92049-1172	1
CIRCLIP,35MM (Ref # 481)	481J3500	1
PIN COTTER 3.0X35 (Ref # 550)	550D3035	1
BEARING,BALL,#6202UC3 (Ref # 601)	601B6202U	1
BEARING BALL (Ref # 601A)	601B6203U	1