

1986 GPz PARTS DIAGRAM

BREATHER COVER/OIL PAN

E1432-0027

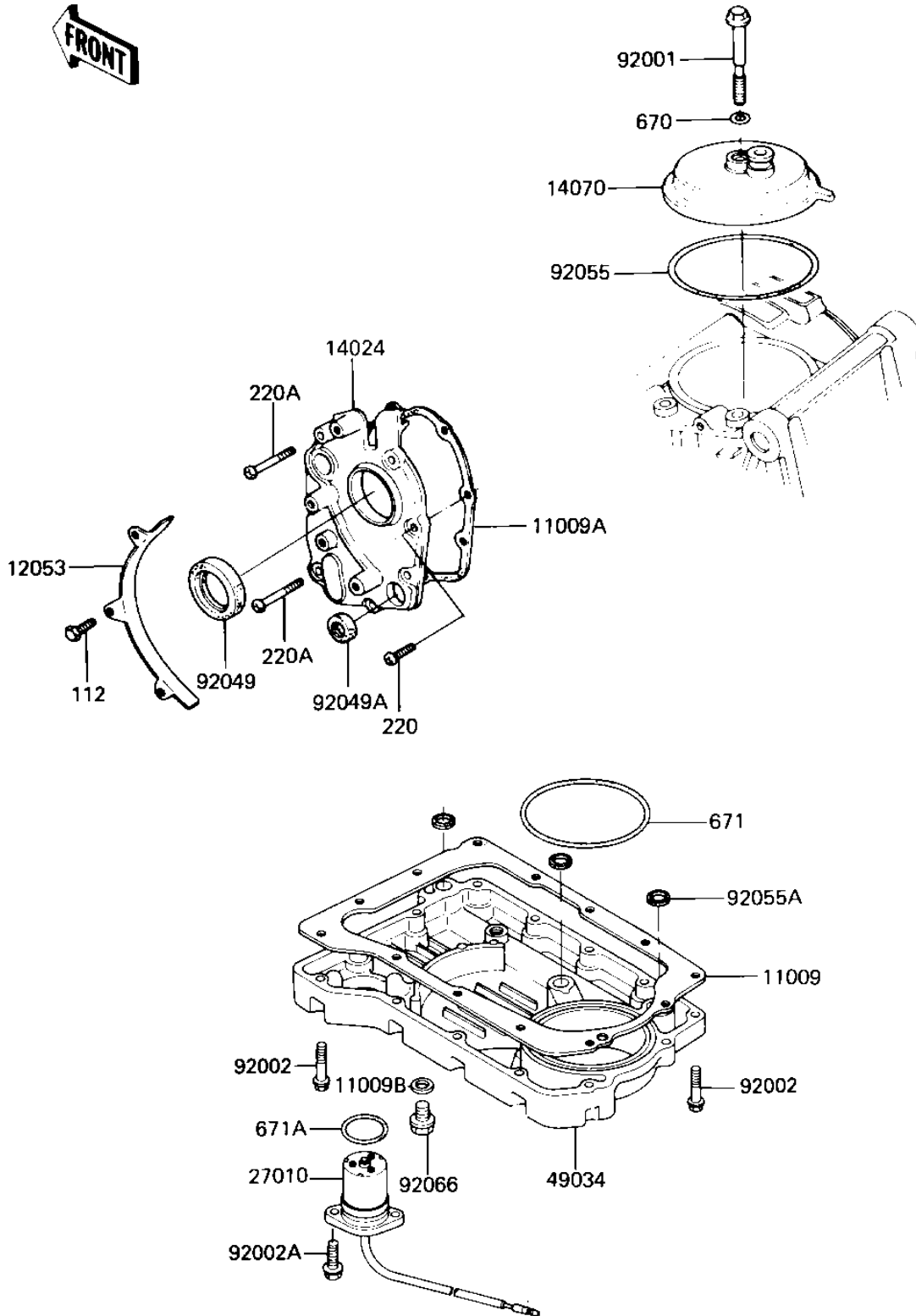

1986 GPz PARTS LIST

BREATHER COVER/OIL PAN

ITEM NAME	PART NUMBER	QUANTITY
GASKET,OIL PAN (Ref # 11009)	11060-1057	1
GASKET,TRANSMISSION C (Ref # 11009A)	11060-1056	1
GASKET,DRIN PLUG (Ref # 11009B)	92065-097	1
GUIDE,CHAIN (Ref # 12053)	12053-1006	1
COVER,MISSION (Ref # 14024)	14025-1700	1
BODY-BREATHER,BLACK (Ref # 14070)	14070-1010	1
SWITCH,OIL LEVEL (Ref # 27010)	27010-1057	1
PAN-OIL (Ref # 49034)	49034-1081	1
BOLT,8X72,BLACK (Ref # 92001)	92001-1526	1
BOLT,6X25 (Ref # 92002)	92002-1089	13
BOLT,6X16 (Ref # 92002A)	92002-1100	2
OIL SEAL SC325210 (Ref # 92049)	92050-024	1
OIL SEAL,TB13225.5 (Ref # 92049A)	92051-005	1
"O" RING,91MM (Ref # 92055)	92055-052	1
"O" RING (Ref # 92055A)	92055-077	3
PLUG,OIL DRAIN,12X15 (Ref # 92066)	92066-1174	1
BOLT-UPSET 6X14 (Ref # 112)	112B0614	3
SCREW PAN HEAD 6X20 (Ref # 220)	220B0620	5
SCREW PAN HEAD 6X40 (Ref # 220A)	220B0640	2
"O" RING,8MM (Ref # 670)	670B1508	1
"O" RING,90MM (Ref # 671)	671B2590	1
O RING,25MM (Ref # 671A)	671E2525	1