

1985 GPz PARTS DIAGRAM

FRAME FITTINGS

F2131-0173

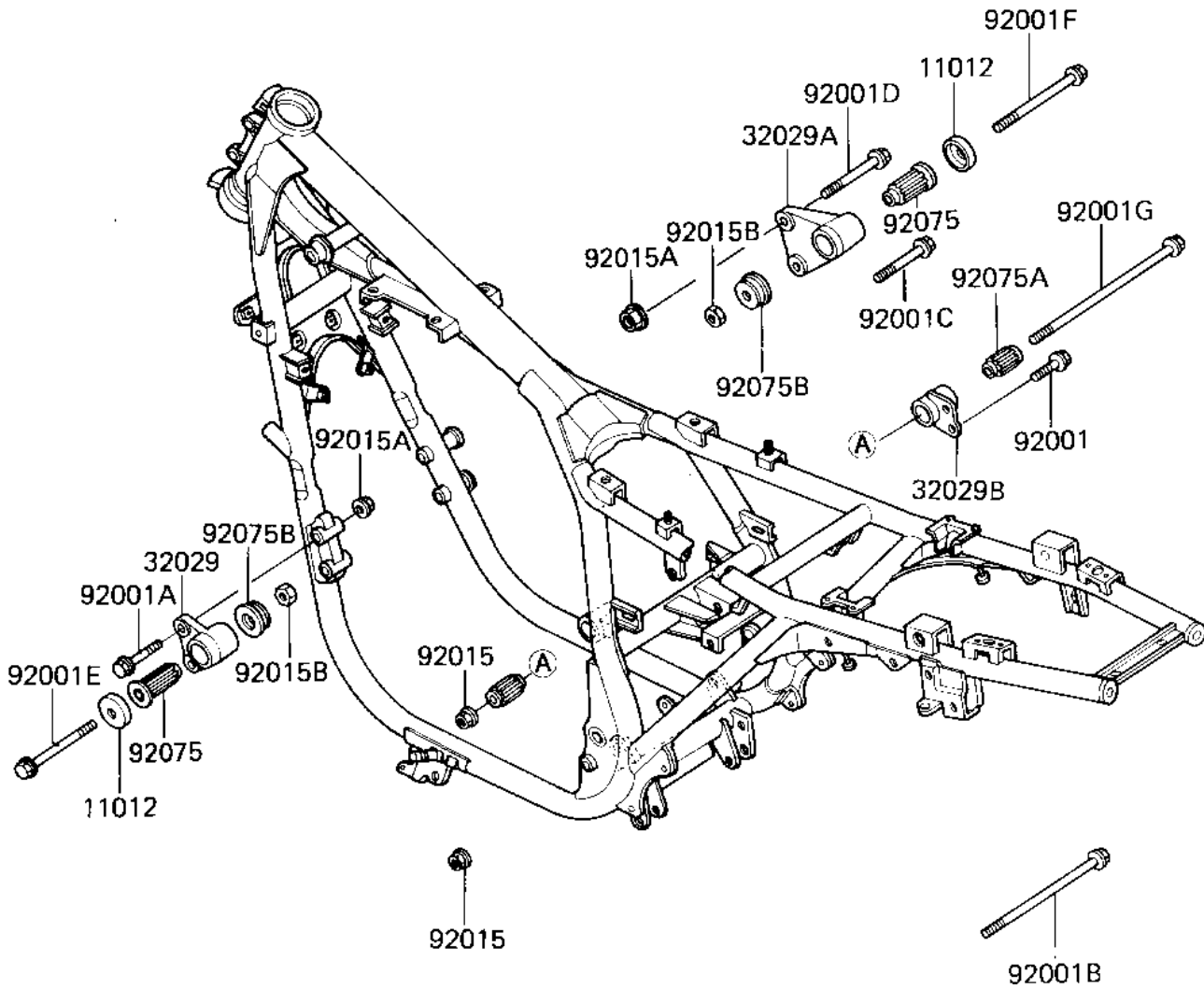

1985 GPz PARTS LIST

FRAME FITTINGS

ITEM NAME	PART NUMBER	QUANTITY
CAP,ENGINE BRACKET (Ref # 11012)	11012-1228	2
BRACKET-ENGINE,FR,LH (Ref # 32029)	32029-1192	1
BRACKET-ENGINE,FR,RH (Ref # 32029A)	32029-1193	1
BRACKET-ENGINE,RR,UPP (Ref # 32029B)	32029-1259	1
BOLT,FLANGED,8X28,BLA (Ref # 92001)	92001-1508	2
BOLT,FLANGED,8X60 (Ref # 92001A)	92001-1615	2
BOLT,FLANGED,10X180 (Ref # 92001B)	92001-1621	1
BOLT,FLANGED,8X75,BLA (Ref # 92001C)	92001-1642	1
BOLT,FLANGED,8X85 (Ref # 92001D)	92001-1718	1
BOLT,FLANGED,10X110 (Ref # 92001E)	92001-1719	1
BOLT,FLANGED,10X125 (Ref # 92001F)	92001-1720	1
BOLT,FLANGED,10X240 (Ref # 92001G)	92001-1812	1
NUT,FLANGED,10MM,BLAC (Ref # 92015)	92015-1180	2
NUT,FLANGED,8MM (Ref # 92015Q)	92015-1408	4
NUT,LOCK,10MM,BLACK (Ref # 92015B)	92015-1188	2
DAMPER,ENGINE BRACKET (Ref # 92075)	92075-1377	2
DAMPER,11X29X42X7 (Ref # 92075A)	92075-1379	2
DAMPER (Ref # 92075B)	92075-1274	2