

1986 GPz PARTS DIAGRAM

TURN SIGNALS

F2730-0119

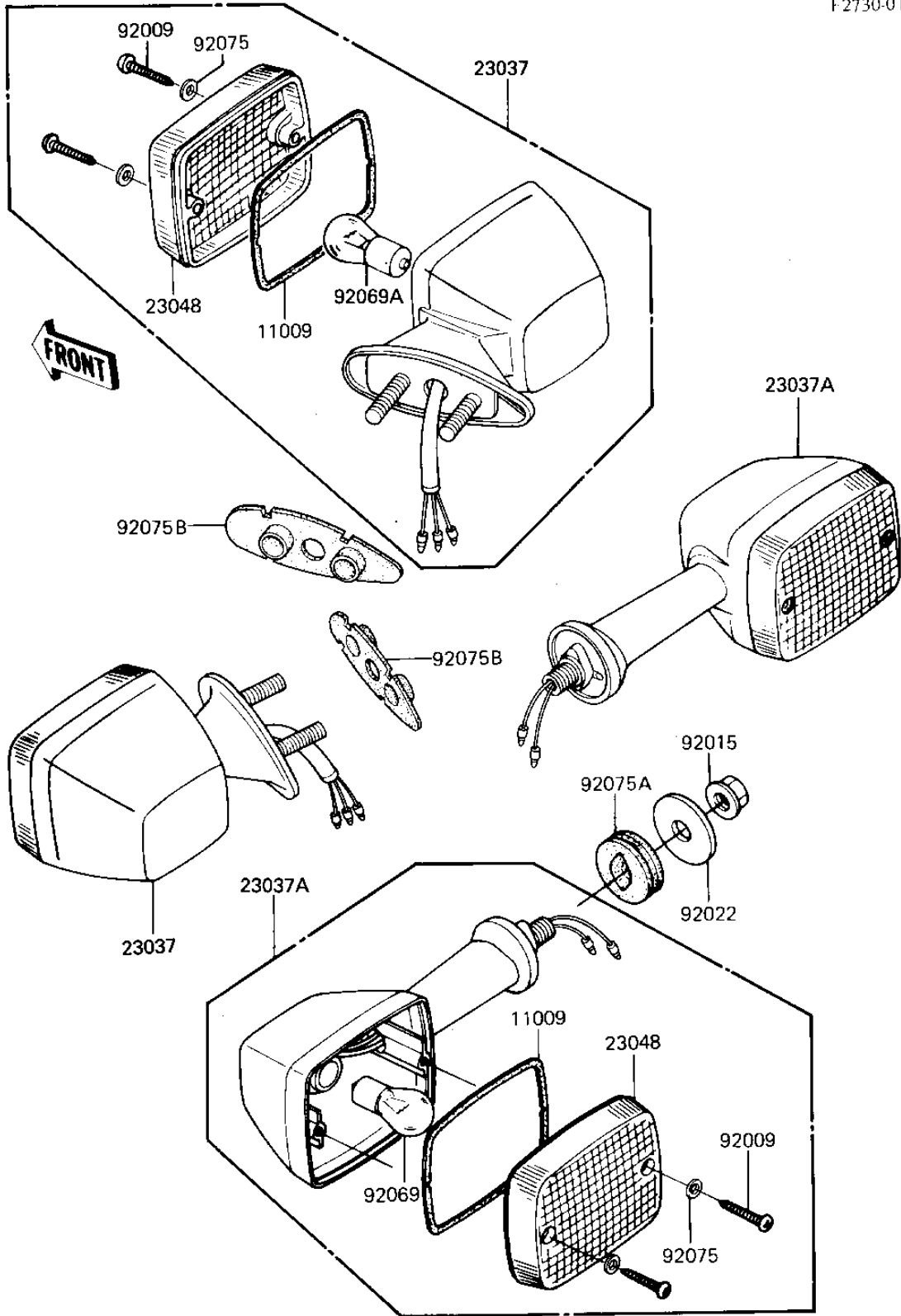

1986 GPz PARTS LIST

TURN SIGNALS

ITEM NAME	PART NUMBER	QUANTITY
GASKET,SIGNAL LAMP (Ref # 11009)	11009-1150	4
LAMP-ASSY-SIGNAL,FR (Ref # 23037)	23037-1150	2
LAMP-ASSY-SIGNAL,RR (Ref # 23037A)	23037-1151	2
LENS-SIGNAL LAMP (Ref # 23048)	23048-1019	4
SCREW,TAPPING,4X25 (Ref # 92009)	92009-1069	8
NUT,FLANGED,10MM (Ref # 92015)	92015-1428	2
WASHER,10.5X37X1.6 (Ref # 92022)	92022-1246	2
BULB 12V 32CP (Ref # 92069)	92069-055	2
BULB,12V 23/8W (Ref # 92069A)	92069-060	2
WASHER-PLAIN,4MM (Ref # 92075)	23058-002	8
DAMPER,SIGNAL LAMP (Ref # 92075A)	92075-1391	2
DAMPER,SIGNAL LAMP,FR (Ref # 92075B)	92075-1506	2