

2008 Teryx® 750 4x4 NRA OUTDOORS™ PARTS DIAGRAM

Drive Shaft-Propeller

E3135



Ref. Drive Shaft-Front

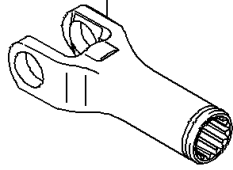

92145

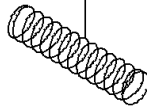

49006

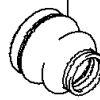

92055A



92055

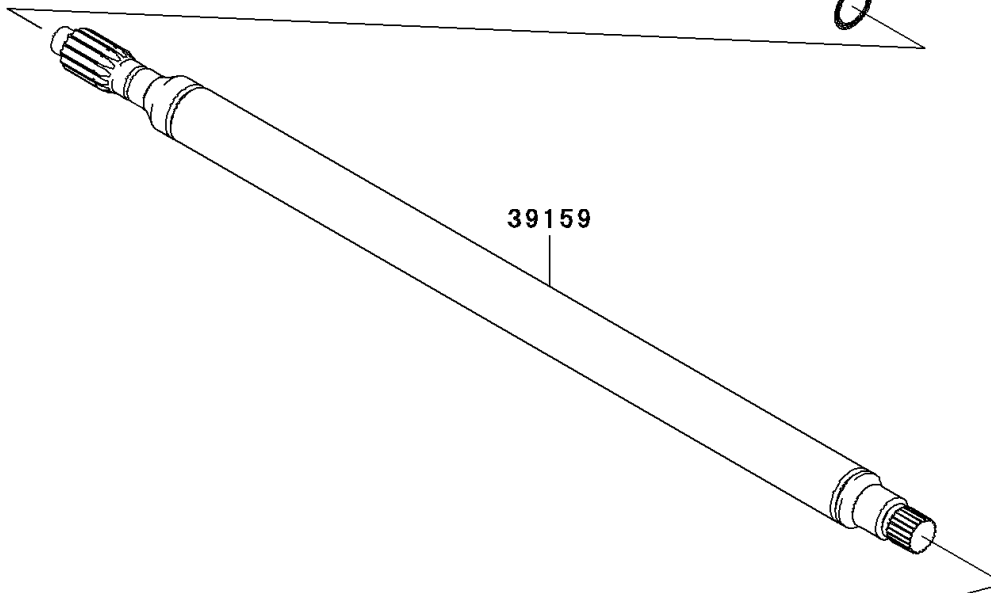

39159

13310

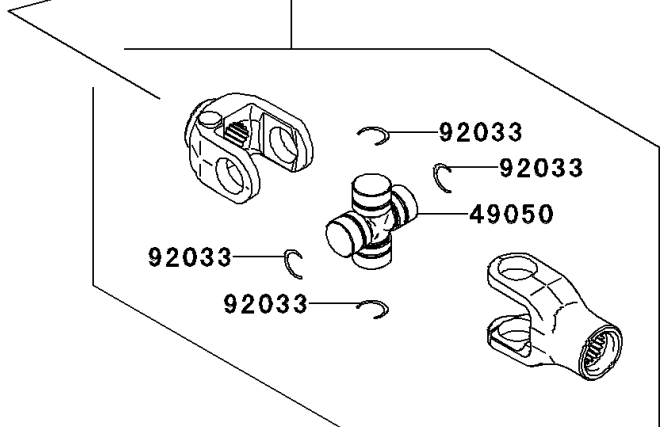

2008 Teryx® 750 4x4 NRA OUTDOORS™ PARTS LIST

Drive Shaft-Propeller

ITEM NAME	PART NUMBER	QUANTITY
SHAFT-ASSY (Ref # 13310)	13310-0017	1
SHAFT-DRIVE (Ref # 39159)	39159-0021	1
BOOT (Ref # 49006)	49006-0010	1
SPIDER (Ref # 49050)	49050-1075	1
RING-SNAP (Ref # 92033)	92033-1030	4
RING-O,18X24X3 (Ref # 92055)	92055-1633	1
RING-O,30X35X2.5 (Ref # 92055A)	92055-1693	1
SPRING (Ref # 92145)	92145-0247	1