

1985 GPz 750 PARTS DIAGRAM

CYLINDER/PISTONS

E1120-0047

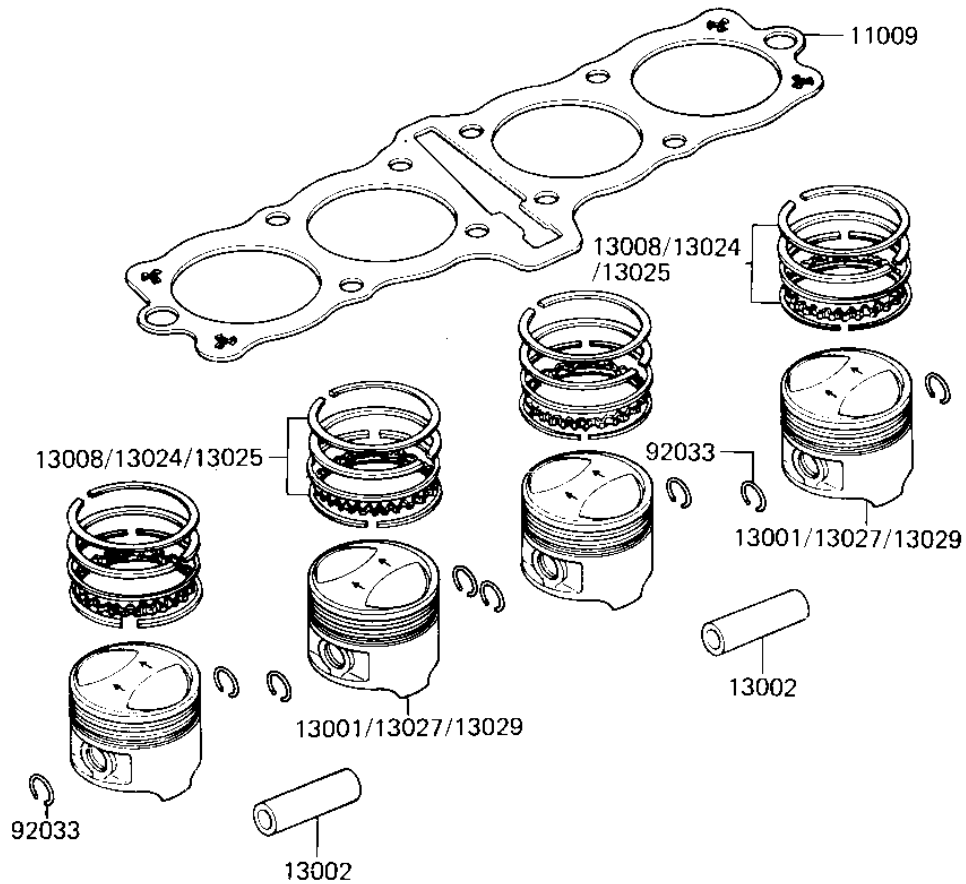
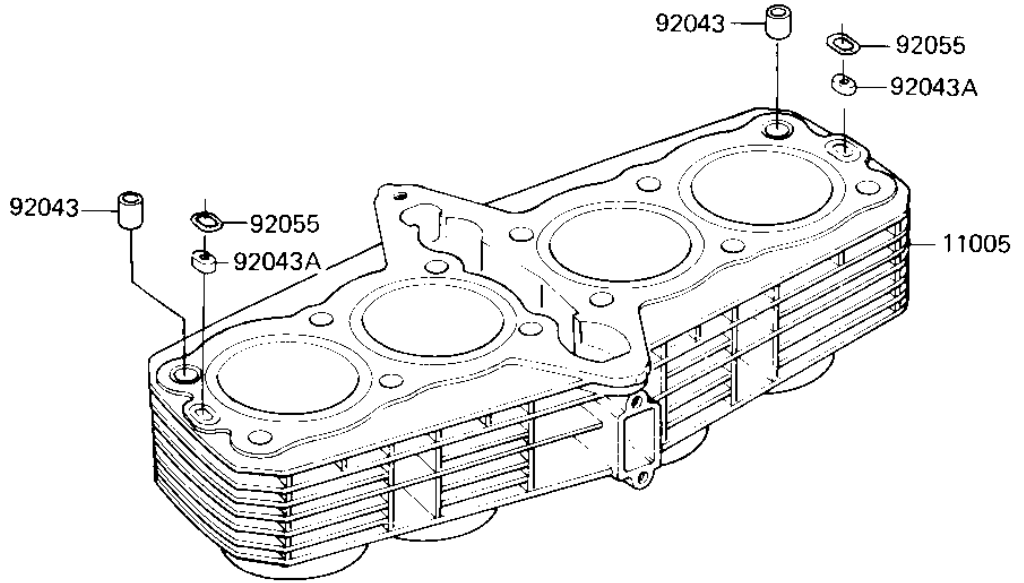

1985 GPz 750 PARTS LIST

CYLINDER/PISTONS

ITEM NAME	PART NUMBER	QUANTITY
CYLINDER-ENGINE,F.BLA (Ref # 11005)	11005-1306	1
GASKET,CYLINDER BASE (Ref # 11009)	11060-1144	1
PISTON-ENGINE,STD (Ref # 13001)	13001-1343	4
PIN-PISTON (Ref # 13002)	13002-1001	4
RING-SET-PISTON,STD (Ref # 13008)	13008-5046	4
RING-SET PISTON LL,01 (Ref # 13024)	13024-5022	4
RING-SET PISTON L,O/S (Ref # 13025)	13025-5022	4
PISTON-ENGINE LL,O/S (Ref # 13027)	13027-1045	4
PISTON-ENGINE L,O/S O (Ref # 13029)	13029-1046	4
CIRCLIP PISTON PIN (Ref # 92033)	92036-005	8
PIN,11X14X12.3 (Ref # 92043)	92043-1266	2
PIN,OIL LINE (Ref # 92043A)	92043-1210	2
RING-O (Ref # 92055)	92055-1147	2