

1984 Voyager PARTS DIAGRAM

IGNITION

E1830-0180

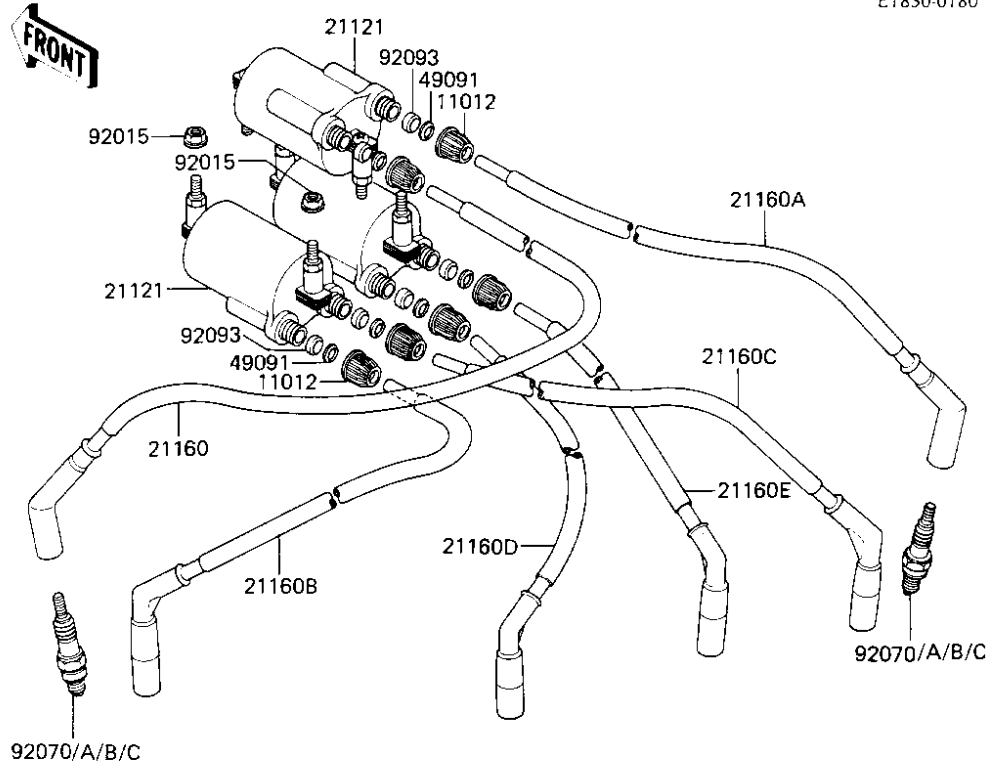

Re	Na
1	
1	
2	
2	
2	
2	
2	
2	
2	
2	
2	
4	
5	
9	
9	
9	
9	
9	

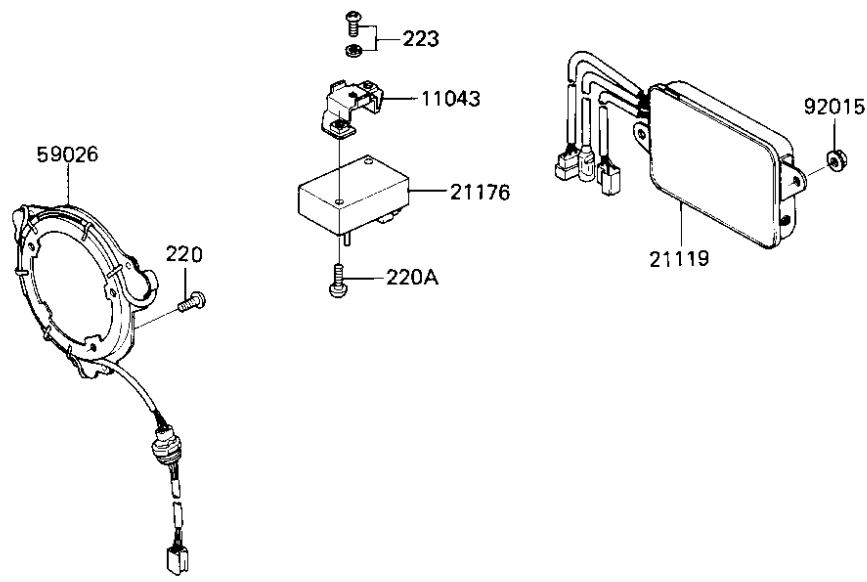

1984 Voyager PARTS LIST

IGNITION

ITEM NAME	PART NUMBER	QUANTITY
CAP,IGNITION COIL (Ref # 11012)	11012-1376	6
BRACKET-B,SENSOR (Ref # 11043)	11043-1338	1
IGNITER (Ref # 21119)	21119-1073	1
COIL-IGNITION,#1 (Ref # 21121)	21121-1112	3
CAP-ASSY-PLUG,#1 (Ref # 21160)	21160-1055	1
CAP-ASSY-PLUG,#6 (Ref # 21160A)	21160-1056	1
CAP-ASSY-PLUG,#2 (Ref # 21160B)	21160-1057	1
CAP-ASSY-PLUG.#5 (Ref # 21160C)	21160-1058	1
UNAVAILABLE IN PRICE BOOK (Ref # 21160D)	21160-105	1
CAP-ASSY-PLUG,#4 (Ref # 21160E)	21160-1060	1
SENSOR,VACUUM (Ref # 21176)	21176-1006	1
WASHER-SEAL (Ref # 49091)	49091-1051	6
COIL-PULSING (Ref # 59026)	59026-1027	1
NUT-6MM (Ref # 92015)	92015-1078	8
SPARK PLUG BPR6ES (Ref # 92070)	BPR6ES	6
SPARK PLUG BPR7ES (Ref # 92070A)	BPR7ES	AR
SEAL (Ref # 92093)	92093-1156	6
SCREW PAN HEAD 6X12 (Ref # 220)	220B0612	3
SCREW-PAN HEAD,6X30 (Ref # 220A)	220C0630	2
SCREW-PAN-WS-CROS (Ref # 223)	223C0612	1