

1984 GPz 750 Turbo PARTS DIAGRAM

STARTER MOTOR/STARTER CLUTCH

EX-100-3000

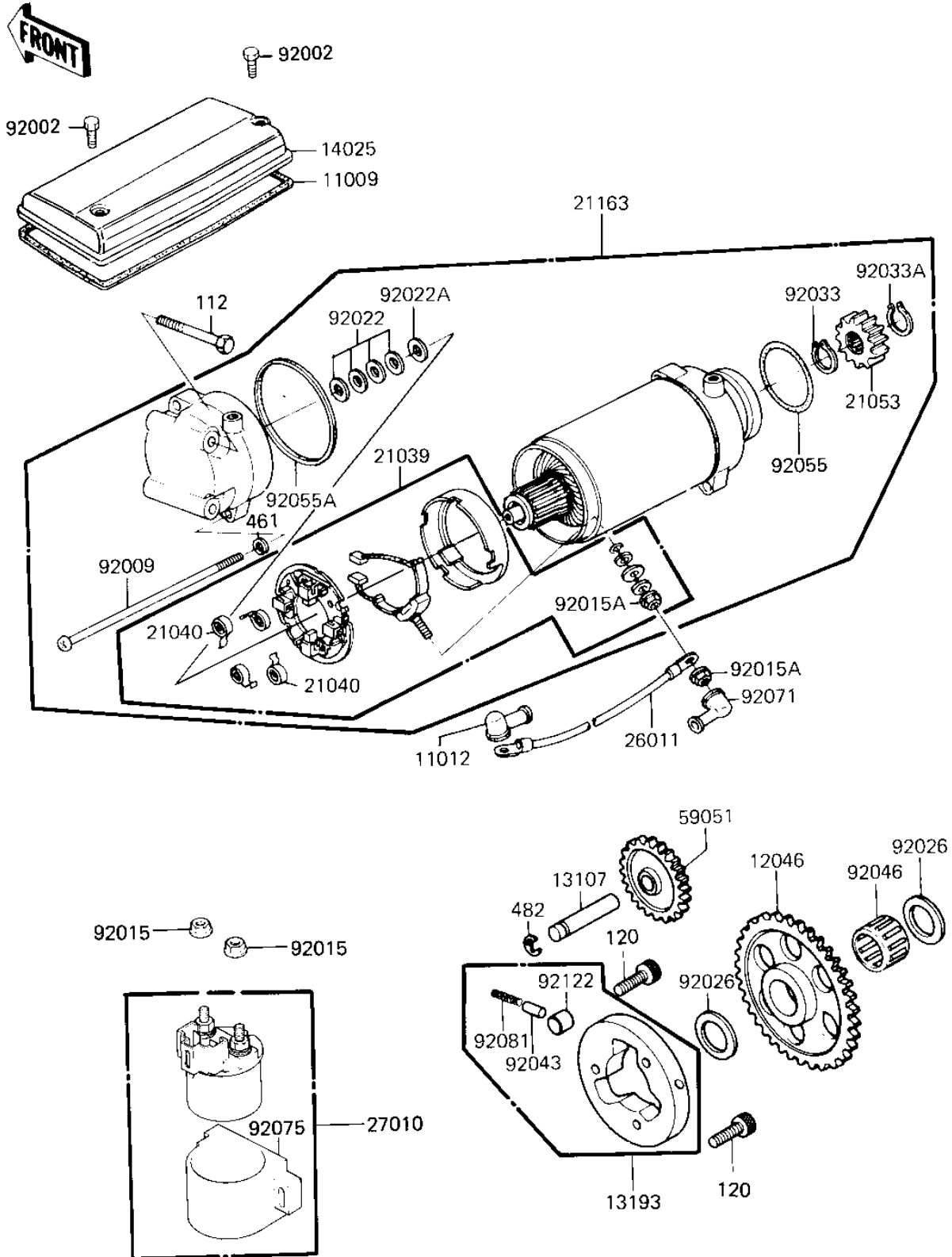

1984 GPz 750 Turbo PARTS LIST

STARTER MOTOR/STARTER CLUTCH

ITEM NAME	PART NUMBER	QUANTITY
GASKET,STARTER COVER (Ref # 11009)	21166-003	1
CAP,TERMINAL (Ref # 11012)	11012-1354	1
SPROCKET,STARTER,58T (Ref # 12046)	12046-1032	1
SHAFT,IDLE GEAR (Ref # 13107)	21143-003	1
CLUTCH-ASSY-ONEWAY (Ref # 13193)	13193-1012	1
COVER,STARTER,F.BLACK (Ref # 14025)	14025-1441	1
BRUSH,CARBON (Ref # 21039)	21039-1053	1
SPRING-BRUSH (Ref # 21040)	21040-1003	4
PINION,STARTER (Ref # 21053)	21053-004	1
STARTER-ELECTRIC (Ref # 21163)	21163-1057	1
WIRE,STARTER MOTOR (Ref # 26011)	26011-1073	1
SWITCH,MAGNETIC (Ref # 27010)	27010-1235	1
GEAR,IDLE,29T (Ref # 59051)	21167-004	1
BOLT,6X10 (Ref # 92002)	92002-1098	2
SCREW,PAN HEAD,6X130 (Ref # 92009)	21099-006	2
NUT-6MM (Ref # 92015)	92015-1078	2
NUT-6MM (Ref # 92015A)	92015-1078	2
WASHER,THRUST,0.2T (Ref # 92022)	21025-011	4
WASHER,THRUST,0.8T (Ref # 92022A)	92022-1132	1
SPACER,25X36X3.2 (Ref # 92026)	92026-1025	2
CIRCLIP (Ref # 92033)	92033-034	1
CIRCLIP,13M/M (Ref # 92033A)	92033-037	1
PIN (Ref # 92043)	92043-087	3
BRG,NEEDLE,K253017 (Ref # 92046)	92046-056	1
"O" RING,40M/M (Ref # 92055)	21027-008	1
"O" RING,STARTER MOTR (Ref # 92055A)	92055-1086	1
GROMMET,CORD (Ref # 92071)	21017-017	1
DAMPER MAG SWITCH SHK (Ref # 92075)	21064-002	1
SPRING (Ref # 92081)	92081-110	3

1984 GPz 750 Turbo PARTS LIST

STARTER MOTOR/STARTER CLUTCH

ITEM NAME	PART NUMBER	QUANTITY
ROLLER (Ref # 92122)	92122-004	3
BOLT-UPSET (Ref # 112)	112G0660	2
BOLT,SOCKET,8X12 (Ref # 120)	120P0812	3
WASHER SPRING 6MM (Ref # 461)	461F0600	2
CIRCLIP 12MM (Ref # 482)	482K0200	1