

1985 GPz 750 Turbo PARTS DIAGRAM

REAR MASTER CYLINDER

F2293-0044

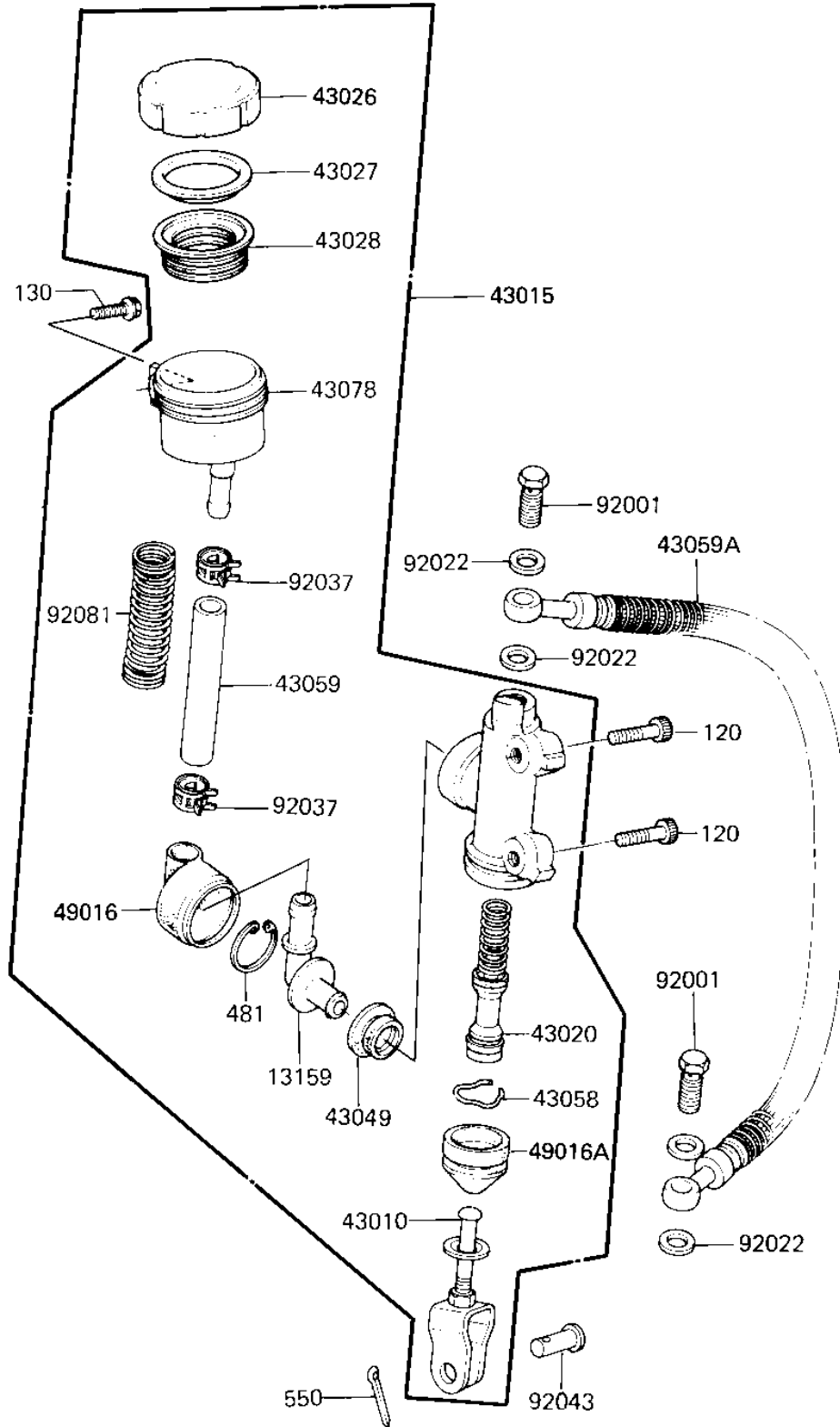

1985 GPz 750 Turbo PARTS LIST

REAR MASTER CYLINDER

ITEM NAME	PART NUMBER	QUANTITY
CONNECTOR (Ref # 13159)	13159-1009	1
ROD-ASSY-BRAKE (Ref # 43010)	43010-1051	1
CYLINDER-ASSY-MASTER. (Ref # 43015)	43015-1255	1
PISTON-COMP-BRAKE (Ref # 43020)	43020-1035	1
CAP-BRAKE (Ref # 43026)	43026-1016	1
PLATE,DIAPHRAGM (Ref # 43027)	43027-1005	1
DIAPHRAGM (Ref # 43028)	43028-1016	1
PACKING (Ref # 43049)	43049-1008	1
RING,DUST SEAL (Ref # 43058)	43058-004	1
HOSE-BRAKE (Ref # 43059)	43059-1100	1
HOSE-BRAKE,L=630 (Ref # 43059A)	43059-1165	1
RESERVOIR (Ref # 43078)	43078-1009	1
COVER-SEAL (Ref # 49016)	49016-1034	1
COVER-SEAL,BRAKE PIST (Ref # 49016A)	49016-1048	1
BOLT,OIL,L=23 (Ref # 92001)	92002-1888	2
WASHER-OIL BOLT (Ref # 92022)	43067-001	4
CLAMP,BRAKE HOSE (Ref # 92037)	92037-1386	2
PIN (Ref # 92043)	92043-1013	1
SPRING HOSE PROTECTOR (Ref # 92081)	92081-1335	1
BOLT (Ref # 120)	120P0835	2
BOLT,FLANGED,6X20 (Ref # 130)	130B0620	1
CIRCRIP-TYPE-C (Ref # 481)	481J2500	1
PIN COTTER 2.0X15 (Ref # 550)	550D2015	1