

1985 GPz 750 Turbo PARTS DIAGRAM

CHASSIS ELECTRICAL EQUIPMENT

F2760-0275

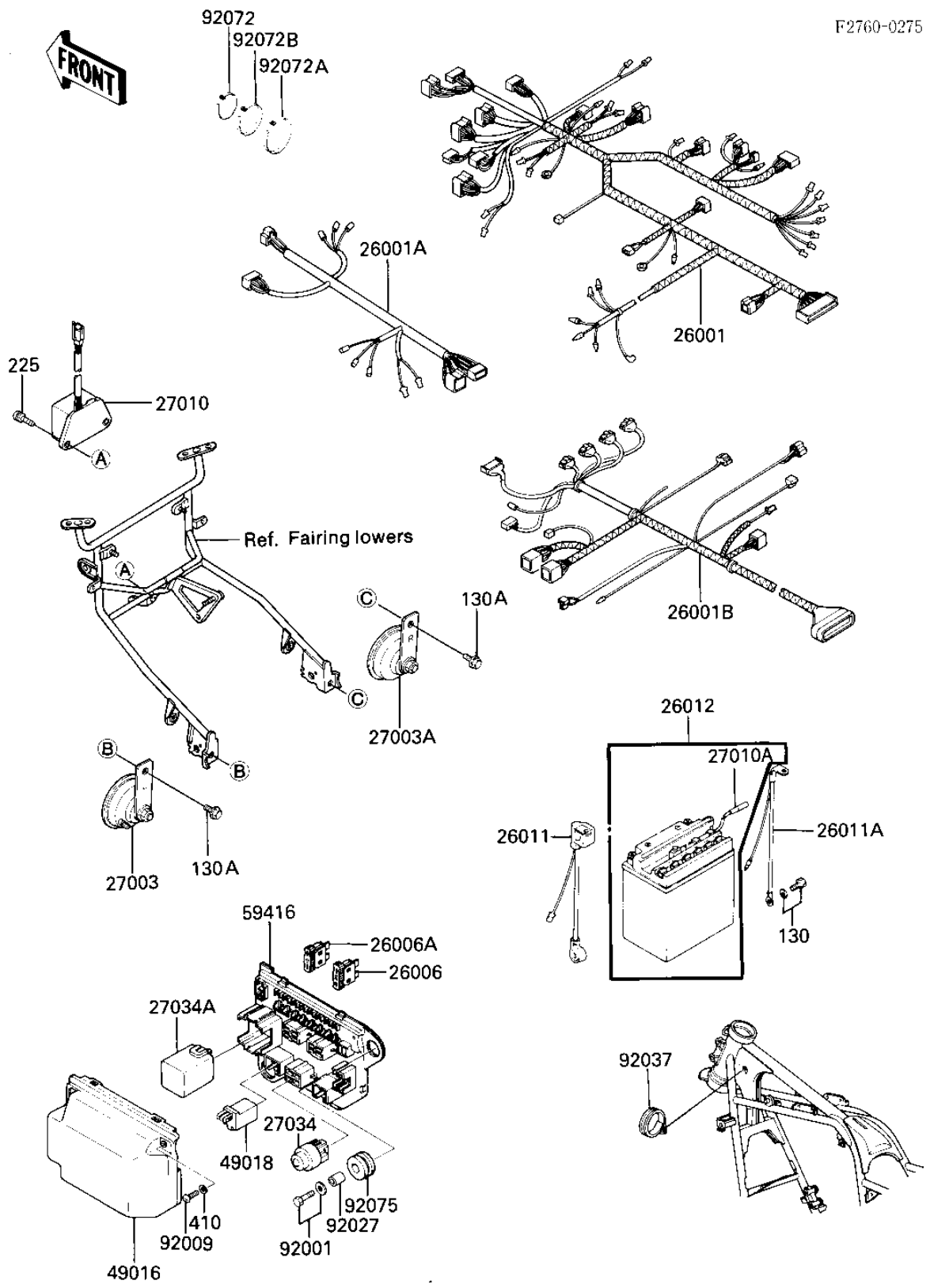

1985 GPz 750 Turbo PARTS LIST

CHASSIS ELECTRICAL EQUIPMENT

ITEM NAME	PART NUMBER	QUANTITY
HARNESS,MAIN (Ref # 26001)	26001-1558	1
HARNESS,FR (Ref # 26001A)	26001-1559	1
HARNESS (Ref # 26001B)	26001-1560	1
FUSE,30A-G (Ref # 26006)	26006-1006	2
FUSE,10A-R (Ref # 26006A)	26006-1007	7
WIRE-LEAD,BATTERY (Ref # 26011)	26011-1257	1
WIRE-LEAD,BATTERY (Ref # 26011A)	26011-1258	1
YUA BAT SYB14L-A2 (Ref # 26012)	26012-1059	1
HORN,LH (Ref # 27003)	27003-1057	1
HORN,RH (Ref # 27003A)	27003-1058	1
SWITCH,RESERVE LIGHTI (Ref # 27010)	27010-1069	1
SWITCH,BATTERY (Ref # 27010A)	27010-1099	1
RELAY,STARTER (Ref # 27034)	27034-1006	3
RELAY,FLASHER (Ref # 27034A)	27034-1007	1
COVER-SEAL (Ref # 49016)	49016-1050	1
DIODE (Ref # 49018)	49018-1006	2
CASE-ELECTRIC (Ref # 59416)	59416-1056	1
BOLT,6X22 (Ref # 92001)	92002-1262	2
SCREW,TAPPING,4X10 (Ref # 92009)	92009-1021	2
COLLAR,REAR FENDER (Ref # 92027)	92027-162	2
CLAMP,HARNESS (Ref # 92037)	92037-1500	2
BAND,MIDDLE (Ref # 92072)	92072-031	2
BAND,LONG (Ref # 92072A)	92072-032	2
BAND,WIRING HARNESS (Ref # 92072B)	92072-056	2
BAND,WIRING HARNESS (Ref # 92075)	92072-056	2
BOLT,FLANGED,6X8 (Ref # 130)	130B0608	1
BOLT-FLANGED,8X12,BLA (Ref # 130A)	130C0812	2
SCREW-PAN-WSP-CROS (Ref # 225)	225B0620	2
WASHER PLAIN 4MM (Ref # 410)	410B0400	2