

1986 KLT110 PARTS DIAGRAM

FRAME FITTINGS

F2131-0164

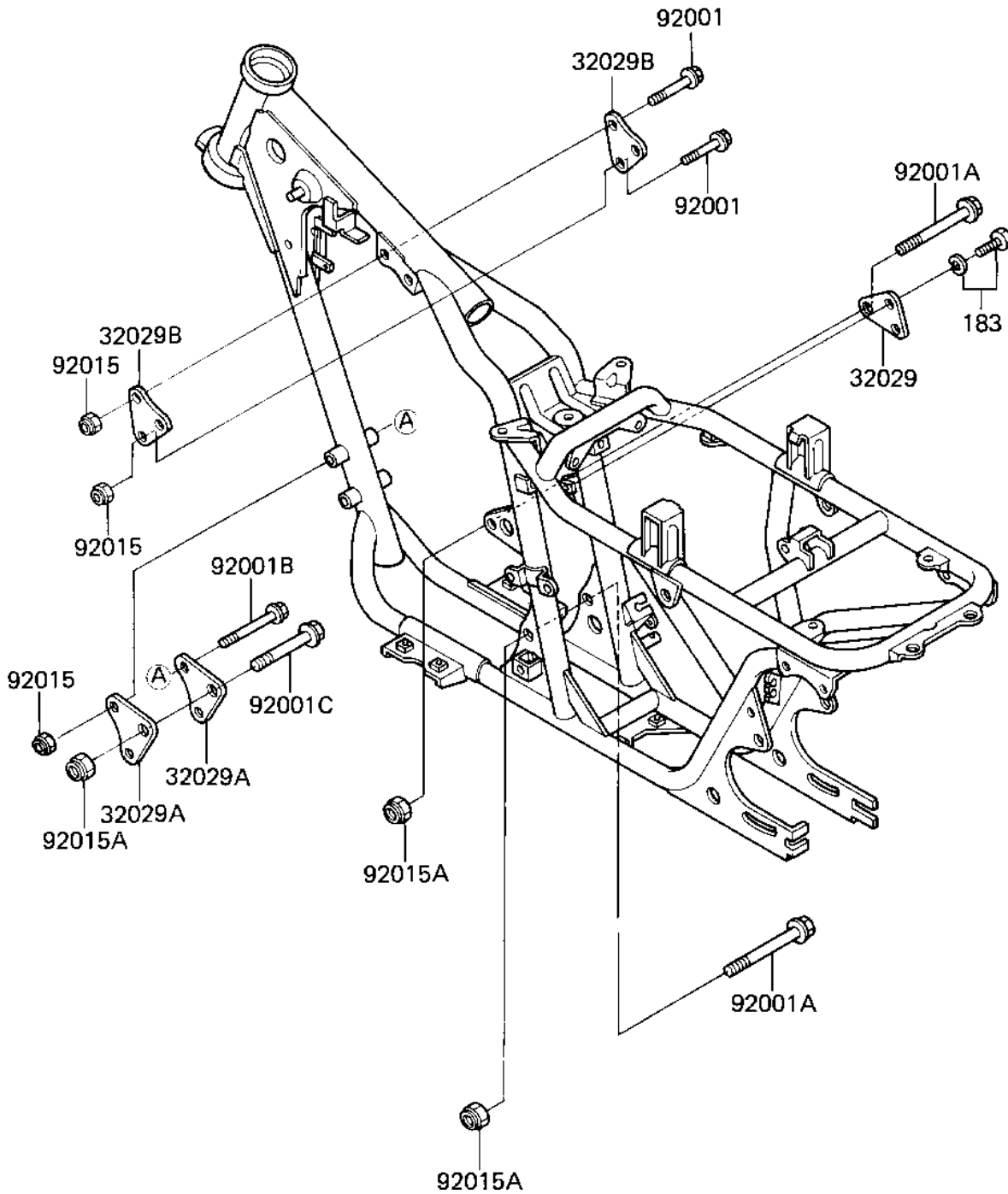

1986 KLT110 PARTS LIST

FRAME FITTINGS

ITEM NAME	PART NUMBER	QUANTITY
BRACKET-ENGINE (Ref # 32029)	32029-4028	1
BRACKET,ENGINE,FRONT (Ref # 32029A)	32029-4037	2
BRACKET,ENGINE,TOP (Ref # 32029B)	32029-4038	2
BOLT,FLANGED,8X55,BLA (Ref # 92001)	92001-1641	3
BOLT,FLANGED,10X105 (Ref # 92001A)	92001-1651	2
BOLT,FLANGED,8X75 (Ref # 92001B)	92002-1481	2
BOLT,10X75 (Ref # 92001C)	92001-4021	1
NUT,LOCK,8MM (Ref # 92015)	92015-1124	5
NUT,LOCK,10MM (Ref # 92015A)	92019-021	3
BOLT-UPSET-WS-SMALL (Ref # 183)	183B0818	2