

1986 KLT110 PARTS DIAGRAM

FRONT HUB/BRAKE (KLT110-A2/A3)

F2230-0120

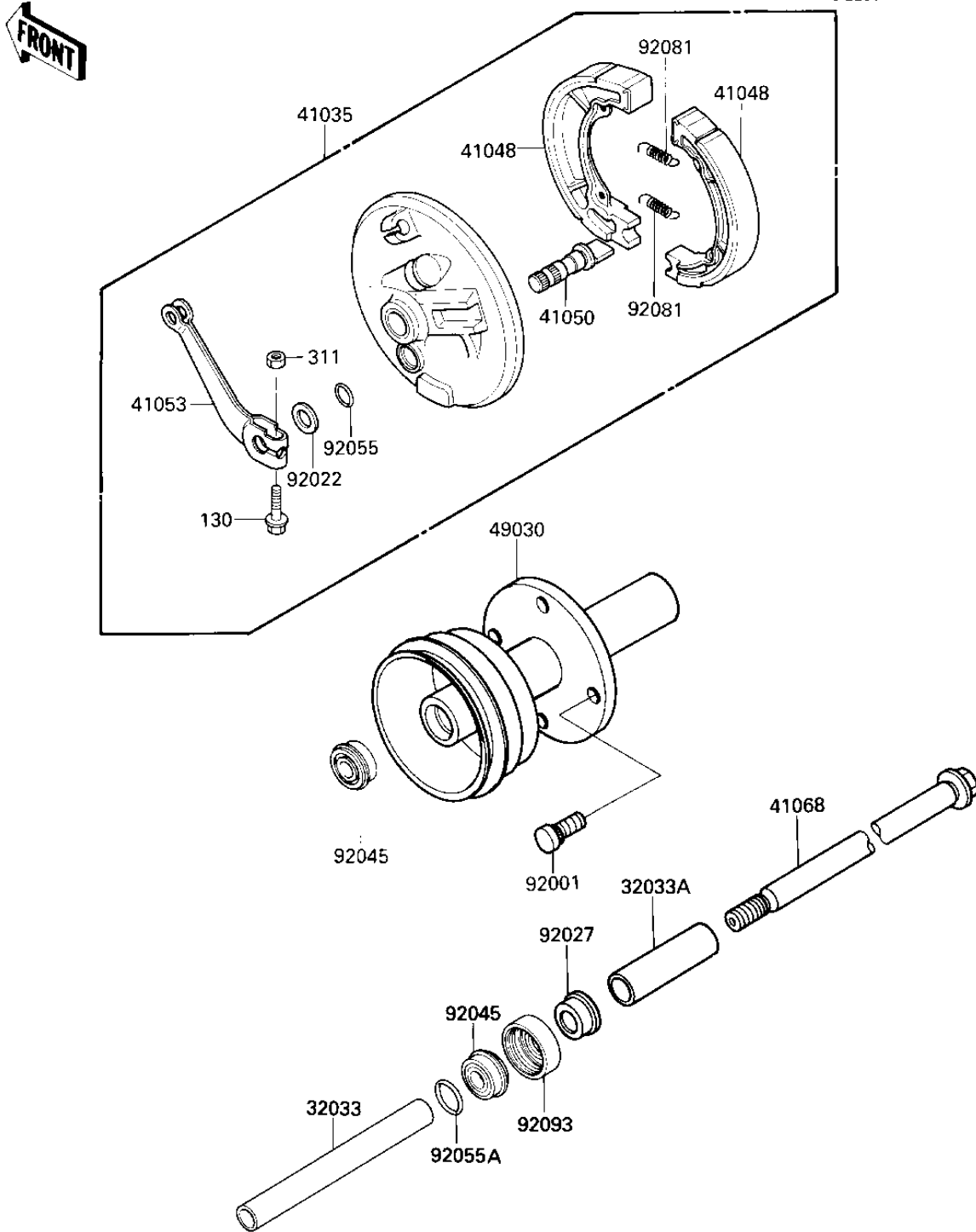

1986 KLT110 PARTS LIST

FRONT HUB/BRAKE (KLT110-A2/A3)

ITEM NAME	PART NUMBER	QUANTITY
PIPE,FR-HUB (Ref # 32033)	32033-1321	1
PIPE,FRONT HUB,L=70 (Ref # 32033A)	32033-1325	1
PANEL-ASSY-BRAKE,FR (Ref # 41035)	41035-1171	1
SHOE-BRAKE (Ref # 41048)	41048-1085	2
CAM-BRAKE (Ref # 41050)	41050-1056	1
LEVER-BRAKE CAM (Ref # 41053)	41053-1055	1
AXLE,FR,L=345 (Ref # 41068)	41068-1173	1
HUB, FR, G.SILVER (Ref # 49030)	49030-1063-F2	1
BOLT,LUG (Ref # 92001)	92001-4006	4
WASHER (Ref # 92022)	92022-257	1
COLLAR (Ref # 92027)	92027-1783	1
BEARING BALL HUB-ASSY (Ref # 92045)	92045-4005	1
"0" RING,11MM (Ref # 92055)	92055-004	1
"0" RING (Ref # 92055A)	92055-4001	1
SPRING,BRAKE SHOE (Ref # 92081)	92081-1766	2
SEAL,FR HUB (Ref # 92093)	92093-1157	1
BOLT,FLANGED,6X30 (Ref # 130)	130G0630	1
NUT 6MM (Ref # 311)	311B0600	1