

1984 KX80 PARTS DIAGRAM

REAR SUSPENSION ('84 KX80-E2)

F 215U-0026

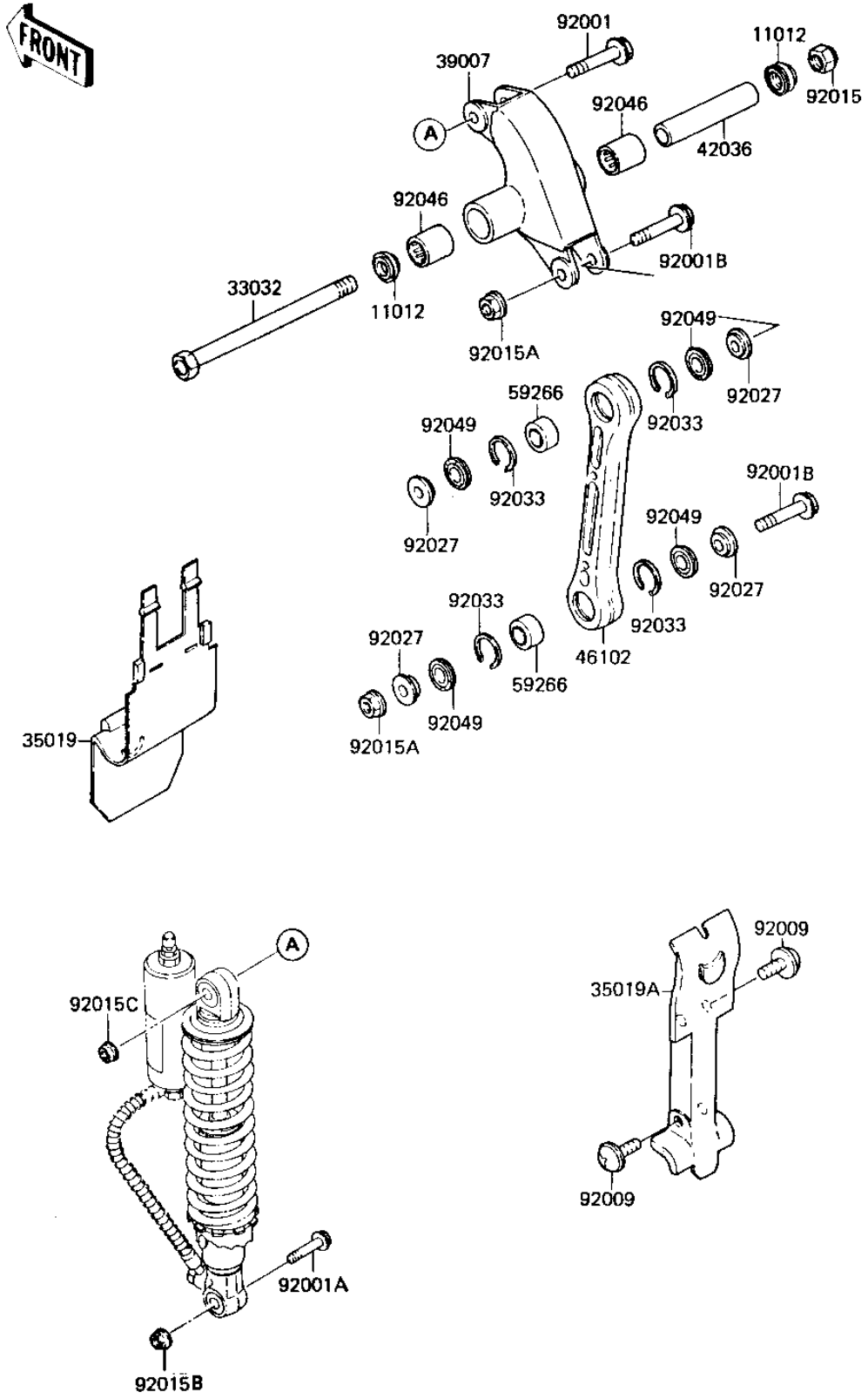

1984 KX80 PARTS LIST

REAR SUSPENSION ('84 KX80-E2)

ITEM NAME	PART NUMBER	QUANTITY
CAP,SWING ARM (Ref # 11012)	11012-1263	2
SHAFT-SUSPENSION ARM, (Ref # 33032)	33032-1032	1
FLAP,ARM-SUSP (Ref # 35019)	35019-1054	1
FLAP,ROD (Ref # 35019A)	35019-1110	1
ARM-SUSP,UNI-TRAK (Ref # 39007)	39007-1020	1
SLEEVE,SUSPENSION ARM (Ref # 42036)	42036-1068	1
ROD,SUSPENSION (Ref # 46102)	46102-1055	1
JOINT-BALL,ROD (Ref # 59266)	59266-1012	2
BOLT,FLANGED,10X43.5 (Ref # 92001)	92001-1711	1
BOLT,FLANGED,10X40.5 (Ref # 92001A)	92001-1712	1
BOLT (Ref # 92001B)	92001-1736	2
SCREW,6X10 (Ref # 92009)	92009-1286	4
NUT (Ref # 92015)	92015-1774	1
NUT-12MM (Ref # 92015A)	92015-1156	2
NUT,10MM (Ref # 92015B)	92015-1415	1
NUT,LOCK,FLANGED,10MM (Ref # 92015C)	92015-1338	1
COLLAR,ROD (Ref # 92027)	92027-1523	4
RING-SNAP,22.3MM (Ref # 92033)	92033-1071	4
BEARING-NEEDLE,ARM-SU (Ref # 92046)	92046-1050	2
SEAL-OIL,ROD (Ref # 94029)	92049-1099	4