

# 1983 KD80 PARTS DIAGRAM

## GEAR CHANGE MECHANISM

E1370-0009

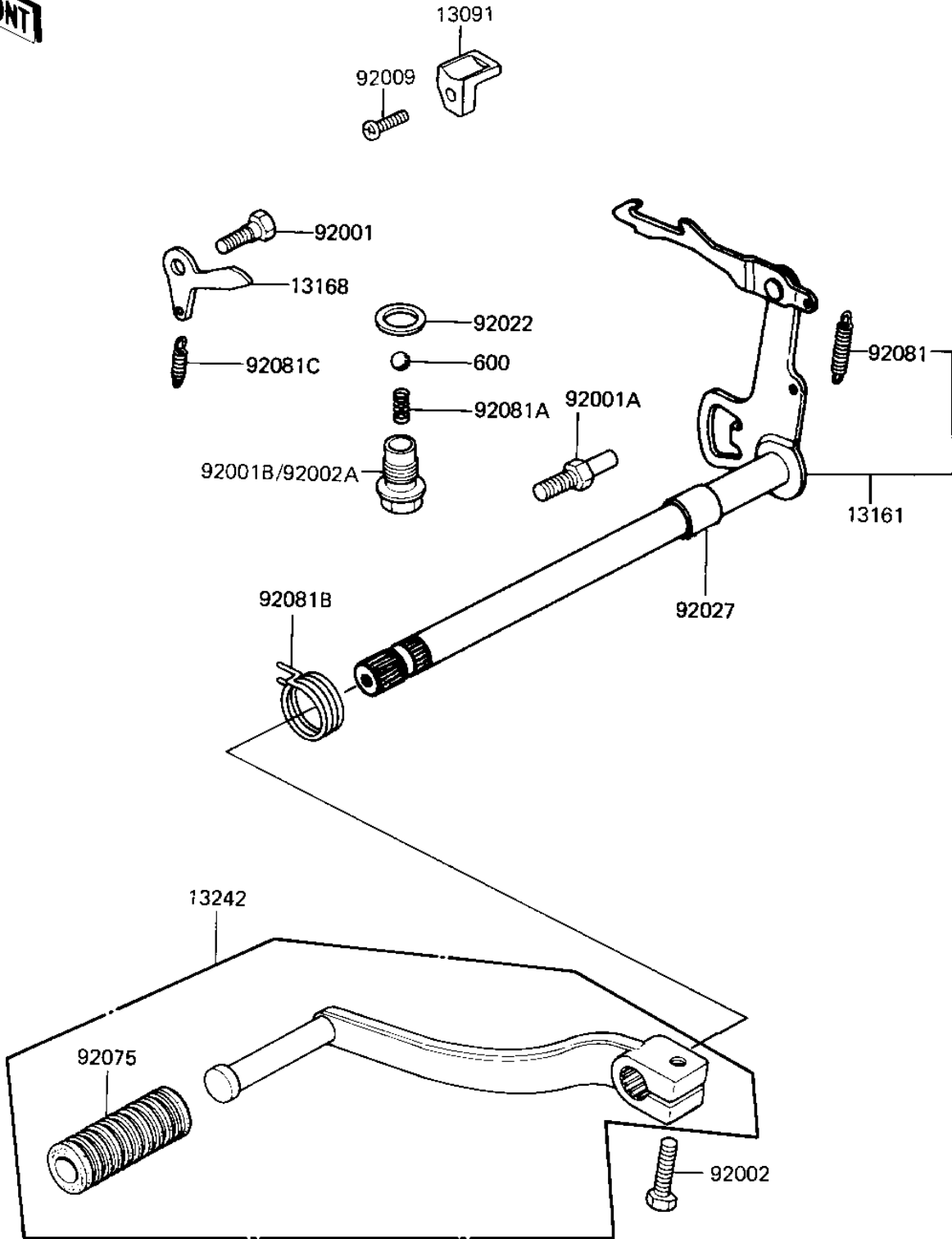

# 1983 KD80 PARTS LIST

## GEAR CHANGE MECHANISM

ITEM NAME	PART NUMBER	QUANTITY
HOLDER (Ref # 13091)	13091-1350	1
LEVER-COMP-CHANGE SFT (Ref # 13161)	13161-1197	1
LEVER,GEAR CHANGE DRM (Ref # 13168)	13168-1046	1
PEDAL SET GEAR CHANGE (Ref # 13242)	13242-004	1
BOLT,CHANGE DRUM LEVE (Ref # 92001)	92150-1450	1
BOLT,RETURN SPRING (Ref # 92001A)	92001-1401	1
BOLT,NEUTRAL POSITION (Ref # 92001B)	92001-182	1
BOLT,6X20 (Ref # 92002)	92002-1237	1
SCREW (Ref # 92009)	92009-1266	1
WASHER,PLAIN (Ref # 92022)	92022-324	1
COLLAR (Ref # 92027)	92027-121	1
RUBBER CHANGE PEDAL (Ref # 92075)	13157-004	1
SPRING,CHANGE LEVER (Ref # 92081)	92144-1720	1
SPRING (Ref # 92081A)	92081-112	1
SPRING,TENTION (Ref # 92081B)	92081-1129	1
SPRING,CHNG DRUM LEV (Ref # 92081C)	92083-012	1
BALL,STEEL,13/32" (Ref # 600)	600A1300	1