

1986 KD80 PARTS DIAGRAM

CRANKCASE

E1411-0108

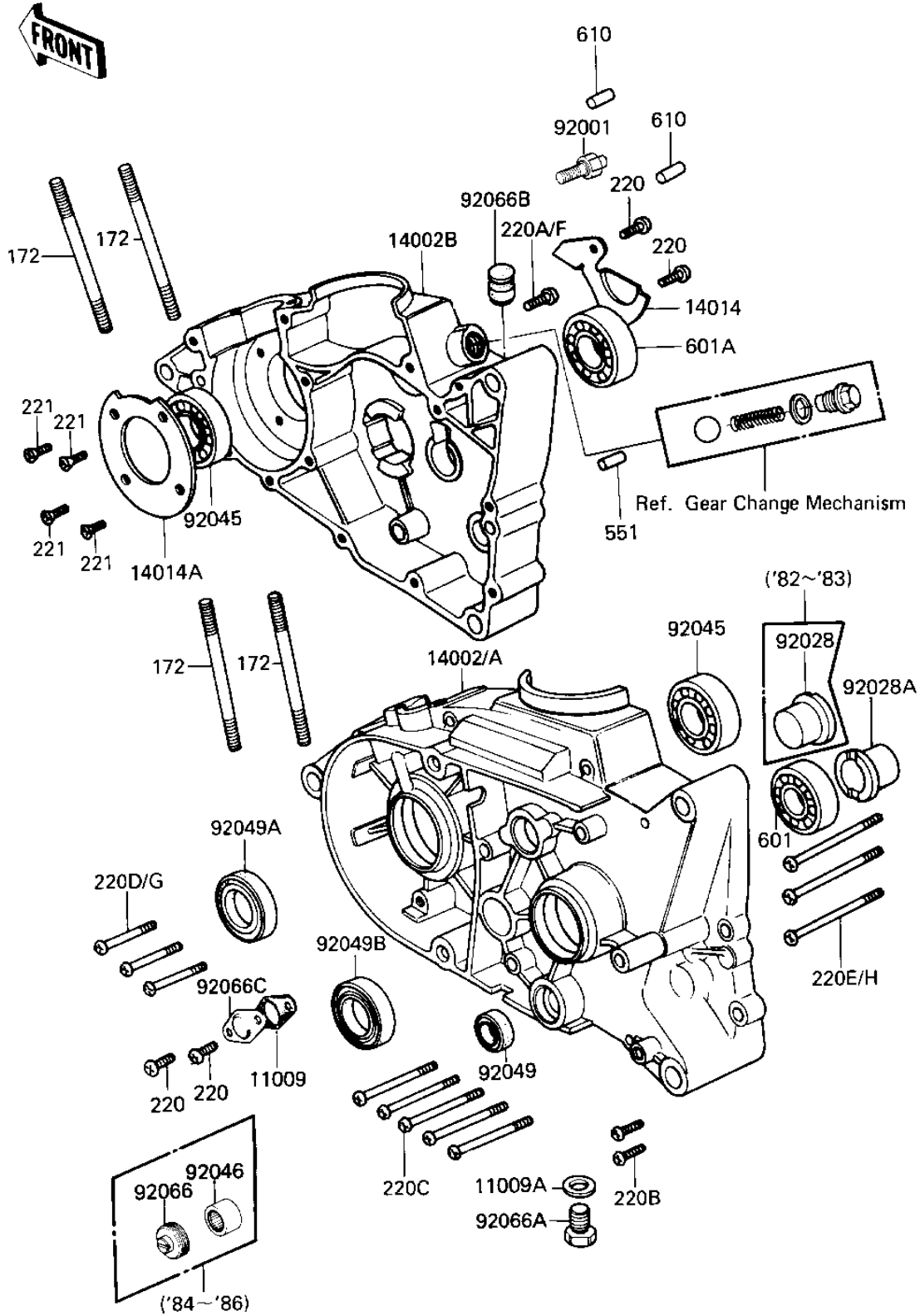

1986 KD80 PARTS LIST

CRANKCASE

ITEM NAME	PART NUMBER	QUANTITY
GASKET NEUTRAL SWITCH (Ref # 11009)	13146-002	1
GASKET CHECK VALVE (Ref # 11009A)	92065-058	1
CRANKCASE,LH (Ref # 14002A)	14002-1181	1
CRANKCASE,RH (Ref # 14002B)	14002-1205	1
HOLDER BEARING MSSON (Ref # 14014)	14014-008	1
HOLDER CRANKSHAFT BRG (Ref # 14014A)	14014-017	1
BOLT,CRANK BRG HOLDER (Ref # 92001)	92001-1426	1
BUSH DRIVE SHAFT (Ref # 92028A)	92028-069	1
BEARING-BALL,#6204 (Ref # 92045)	92045-1032	2
BRG,N,7E-HK1412 (Ref # 92046)	92046-037	1
OIL SEAL SB12205 (Ref # 92049)	92049-004	1
SEAL-OIL (Ref # 92049A)	92049-1240	1
OIL SEAL SC25376 (Ref # 92049B)	92050-013	1
PLUG (Ref # 92066)	92066-1071	1
PLUG OIL DRAIN (Ref # 92066A)	92067-001	1
RUBBER PLUG (Ref # 92066B)	92074-035	1
PLUG-OIL PUMP-HOLE (Ref # 92066C)	92084-004	1
STUD 8X115 (Ref # 172)	172G08115	4
SCREW PAN HEAD 6X12 (Ref # 220)	220B0612	1
SCREW PAN HEAD 6X25 (Ref # 220B)	220B0625	2
SCREW PAN HEAD 6X40 (Ref # 220C)	220B0640	5
SCREW-PAN-CROS (Ref # 220F)	220X0620	1
SCREW-PAN-CROS (Ref # 220G)	220X0660	3
SCREW-PAN-CROS (Ref # 220H)	220X0665	3
SCREW CNTSNK HD 6X16 (Ref # 221)	221B0616	4
PIN DOWEL 8X16 (Ref # 551)	551A0816	3
BEARING BALL #6004 (Ref # 601)	601B6004	1
BEARING BALL #6005 (Ref # 601A)	601B6005	1
PIN DOWEL 5X12 (Ref # 610)	610A0512	2