

# 1983 KD80 PARTS DIAGRAM

FRONT HUB/BRAKE

F2230-0039

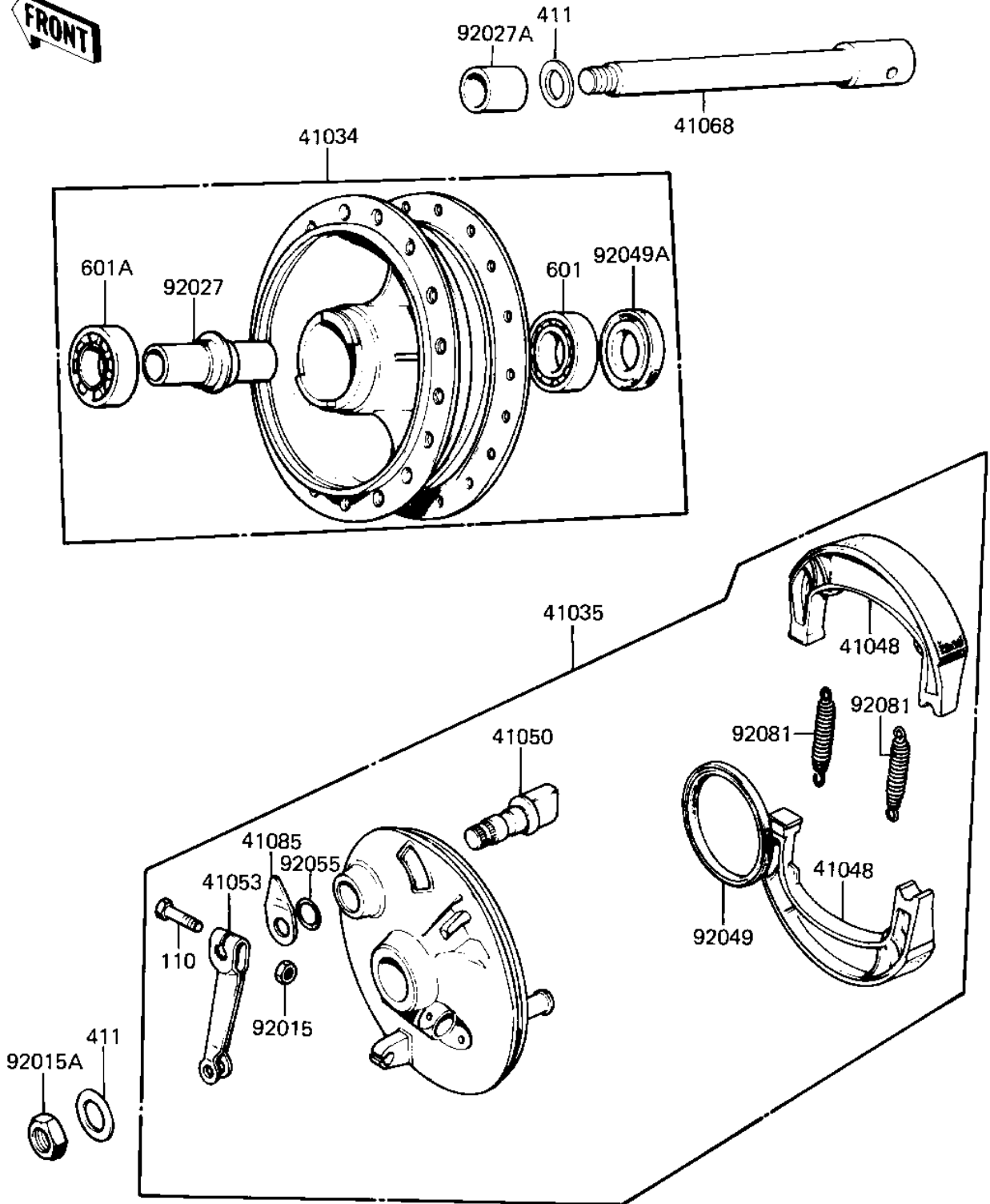

# 1983 KD80 PARTS LIST

## FRONT HUB/BRAKE

ITEM NAME	PART NUMBER	QUANTITY
DRUM-ASSY,FR BRK (Ref # 41034)	41034-1040	1
PANEL-ASY,FR BRK BUFF (Ref # 41035)	41035-069-80	1
SHOE-BRAKE (Ref # 41048)	41048-1085	2
CAM SHAFT-FRONT BRAKE (Ref # 41050)	41050-018	1
LEVER FRONT BRAKE CAM (Ref # 41053)	41053-005	1
AXLE-FRONT (Ref # 41068)	41068-039	1
INDICATOR,FR BK SHOE (Ref # 41085)	41085-013	1
NUT,6MM (Ref # 92015)	41072-007	1
NUT 10MM (Ref # 92015A)	42045-005	1
SPACER FRONT HUB (Ref # 92027)	41039-002	1
COLLAR,FRONT AXLE (Ref # 92027A)	41069-026	1
OIL SEAL BRAKE PANEL (Ref # 92049)	92050-002	1
OIL SEAL,TC17317 (Ref # 92049A)	92050-063	1
"0" RING,11MM (Ref # 92055)	92055-004	1
SPRING,BRAKE SHOE (Ref # 92081)	92081-1766	2
BOLT-UPSET (Ref # 110)	112G0630	1
WASHER PLAIN 10MM (Ref # 411)	411B1000	2
BEARING BALL #6200 (Ref # 601)	601B6200	1
BEARING BALL #6300 (Ref # 601A)	601B6300Z	1