

1987 X2 PARTS DIAGRAM

CRANKSHAFT/PISTONS

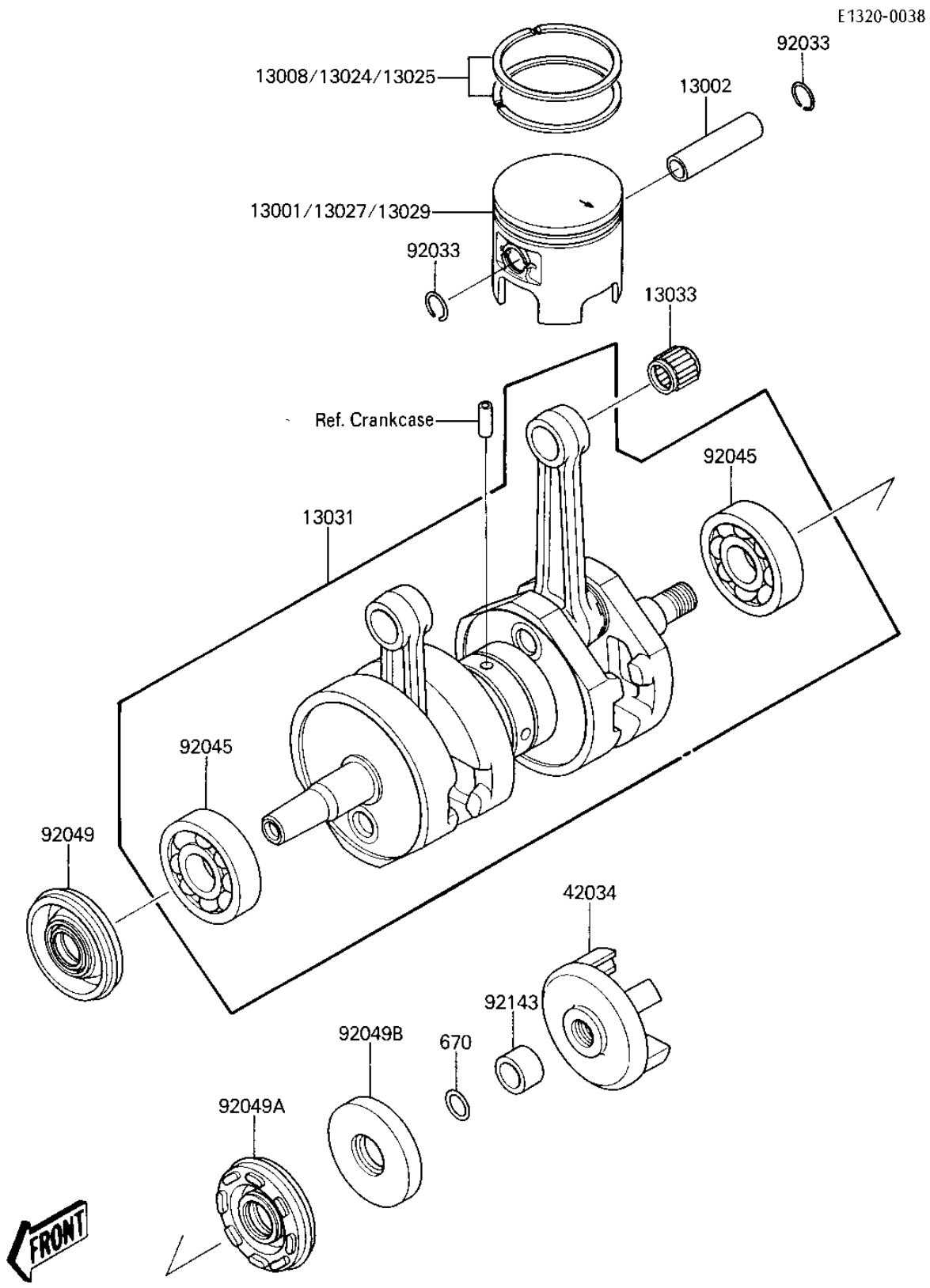

1987 X2 PARTS LIST

CRANKSHAFT/PISTONS

ITEM NAME	PART NUMBER	QUANTITY
PISTON-ENGINE,STD (Ref # 13001)	13001-3705	2
PIN-PISTON (Ref # 13002)	13002-017	2
RING-SET-PISTON,STD (Ref # 13008)	13008-3701	2
RING-SET-PISTON LL,O/ (Ref # 13024)	13024-3701	2
RING-SET-PISTON L,O/S (Ref # 13025)	13025-3701	2
PISTON-ENGINE LL,O/S (Ref # 13027)	13027-3703	2
PISTON-ENGINE L,O/S 0 (Ref # 13029)	13029-3703	2
CRANKSHAFT-COMP (Ref # 13031)	13031-3719	1
BEARING-SMALL END (Ref # 13033)	13033-1010	2
COUPLING (Ref # 42034)	42034-3705	1
CIRCLIP-PISTON PIN (Ref # 92033)	92036-015	4
BEARING,B,6306SH2-9TC (Ref # 92045)	92045-1027	2
SEAL-OIL,FPJ5307210 (Ref # 92049)	92049-3704	1
SEAL-OIL,FWJ15307210 (Ref # 92049A)	92049-3705	1
SEAL-OIL,S30726 (Ref # 92049B)	92049-3706	1
COLLAR (Ref # 92143)	92027-3713	1
"O" RING,14MM (Ref # 670)	670B2014	1