

# 1987 KLT185 PARTS DIAGRAM

CYLINDER HEAD/COVERS

E1111-0168

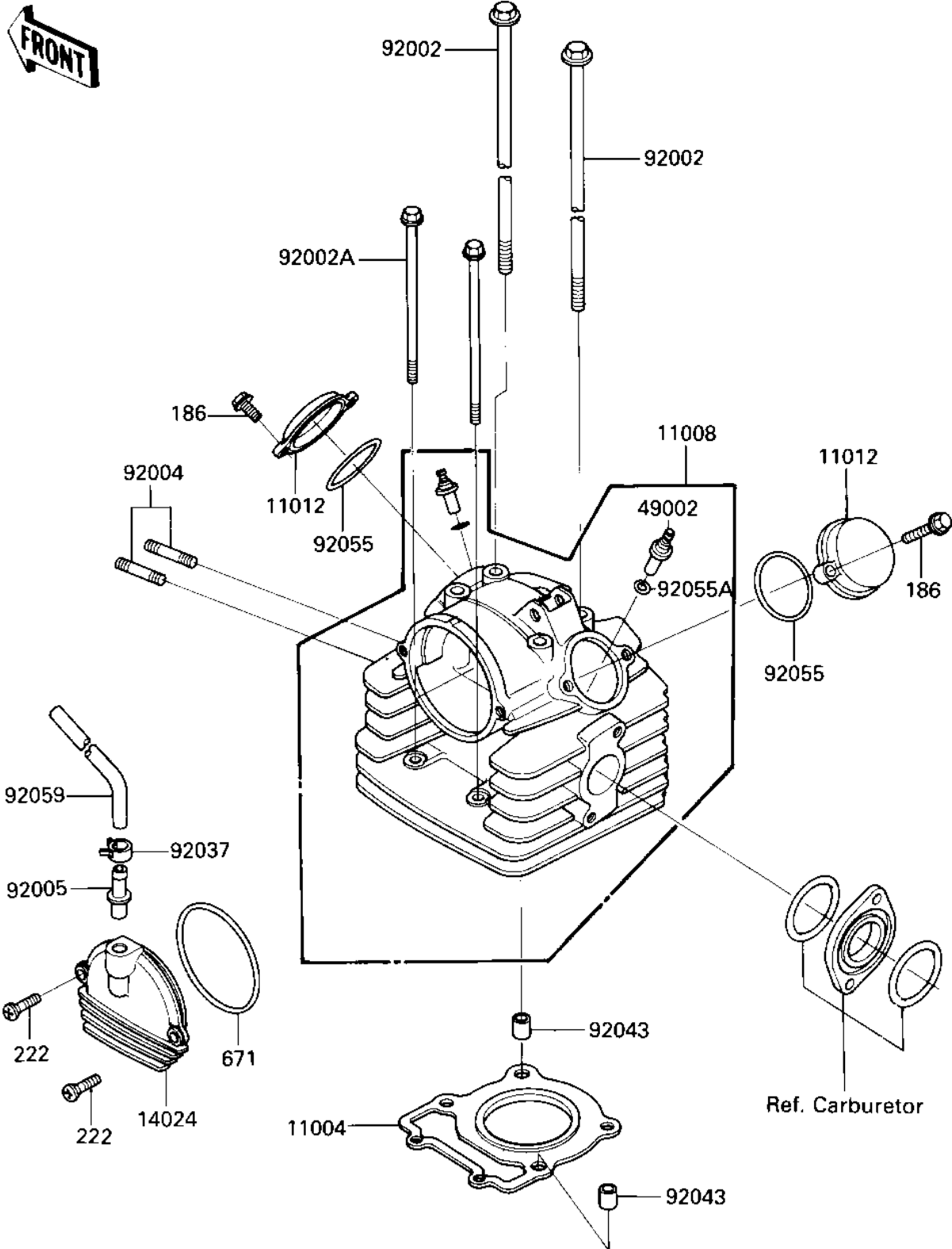

# 1987 KLT185 PARTS LIST

## CYLINDER HEAD/COVERS

ITEM NAME	PART NUMBER	QUANTITY
GASKET-HEAD (Ref # 11004)	11004-1124	1
HEAD-COMP-CYLINDER (Ref # 11008)	11008-1152	1
CAP,ROCKER ARM (Ref # 11012)	11012-1486	2
COVER,CAMSHAFT (Ref # 14024)	14025-1974	1
GUIDE-VALVE (Ref # 49002)	49002-1058	2
BOLT,8X207 (Ref # 92002)	92001-1892	4
BOLT,6X97 (Ref # 92002A)	92001-1893	2
STUD,6X30 (Ref # 92004)	92004-1128	2
FITTING,BREATHER PIPE (Ref # 92005)	92005-1124	1
CLAMP (Ref # 92037)	92037-1181	1
PIN,DOWEL,10X8.2X14 (Ref # 92043)	92043-1037	2
"O" RING,53.5MM (Ref # 92055)	92055-112	2
RING-O,VALVE GUIDE (Ref # 92055A)	92055-1177	2
TUBE (Ref # 92059)	92059-1511	1
BOLT-UPSET-WP (Ref # 186)	186G0625	4
SCREW,OVL CNTSNK,6X16 (Ref # 222)	222E0616	2
"O" RING,95MM (Ref # 671)	671B2595	1