

1987 KLT185 PARTS DIAGRAM

OIL PUMP

E1710-0071

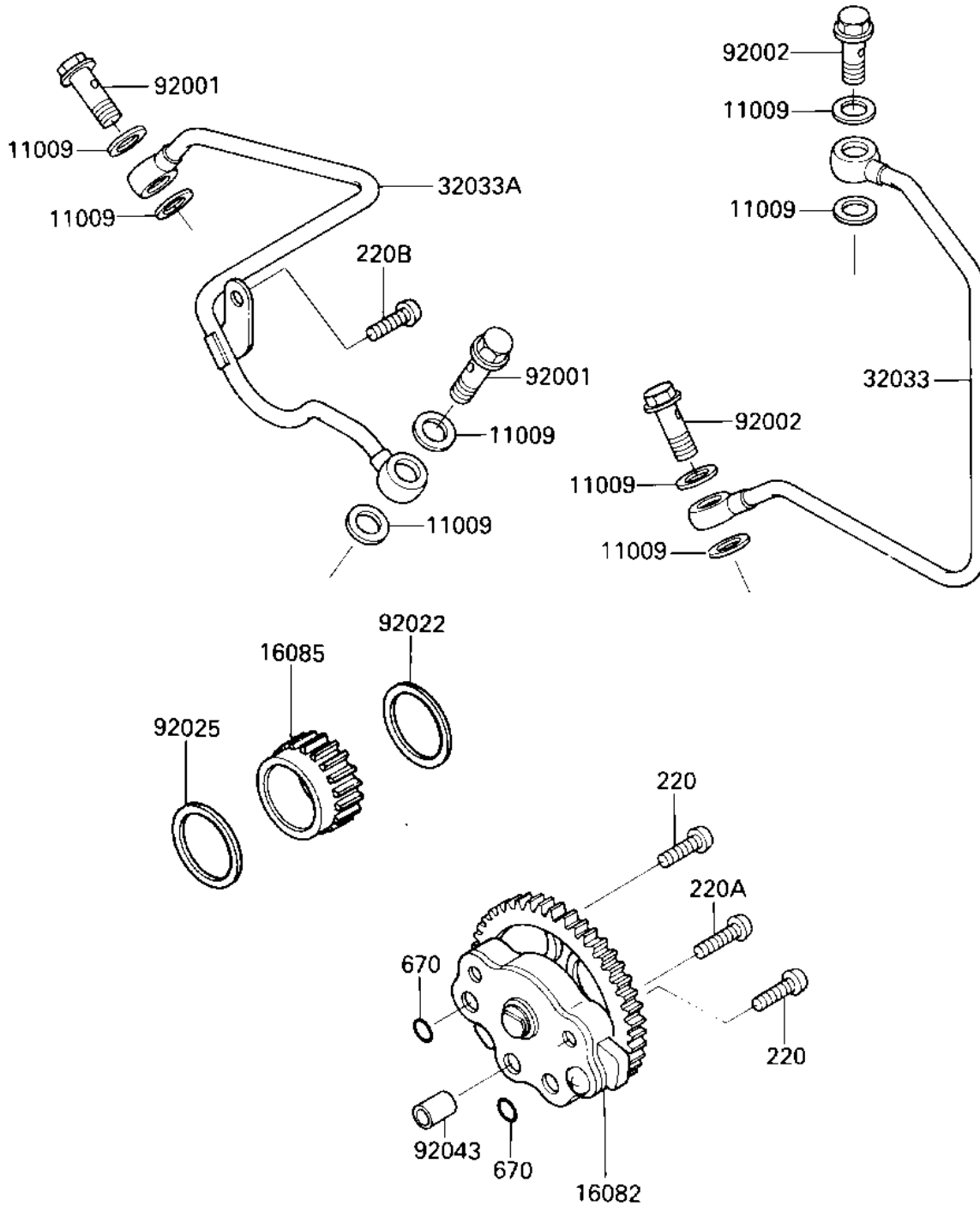

1987 KLT185 PARTS LIST

OIL PUMP

ITEM NAME	PART NUMBER	QUANTITY
GASKET,OIL PIPE,8.2X1 (Ref # 11009)	11009-1344	8
PUMP-ASSY-OIL (Ref # 16082)	16082-1055	1
GEAR,OIL PUMP,22T (Ref # 16085)	16085-1133	1
PIPE,OIL (Ref # 32033)	32033-1221	1
PIPE-OIL (Ref # 32033A)	32033-1222	1
BOLT,BANJO,8X22 (Ref # 92001)	92002-1871	2
BOLT,BANJO,8X20 (Ref # 92002)	92150-1557	2
WASHER (Ref # 92022)	92022-1767	1
SHIM,25.3X36X0.9 (Ref # 92025)	92025-1129	1
PIN,DOWEL,6.2X8X14 (Ref # 92043)	92043-1263	1
SCREW PAN HEAD 6X20 (Ref # 220)	220B0620	2
SCREW PAN HEAD 6X30 (Ref # 220A)	220B0630	1
SCREW-PAN-CROS (Ref # 220B)	220X0612	1
"O"RING 10MM (Ref # 670)	670B1510	2