

1986 KLT185 PARTS DIAGRAM

FRAME

F2120 0280

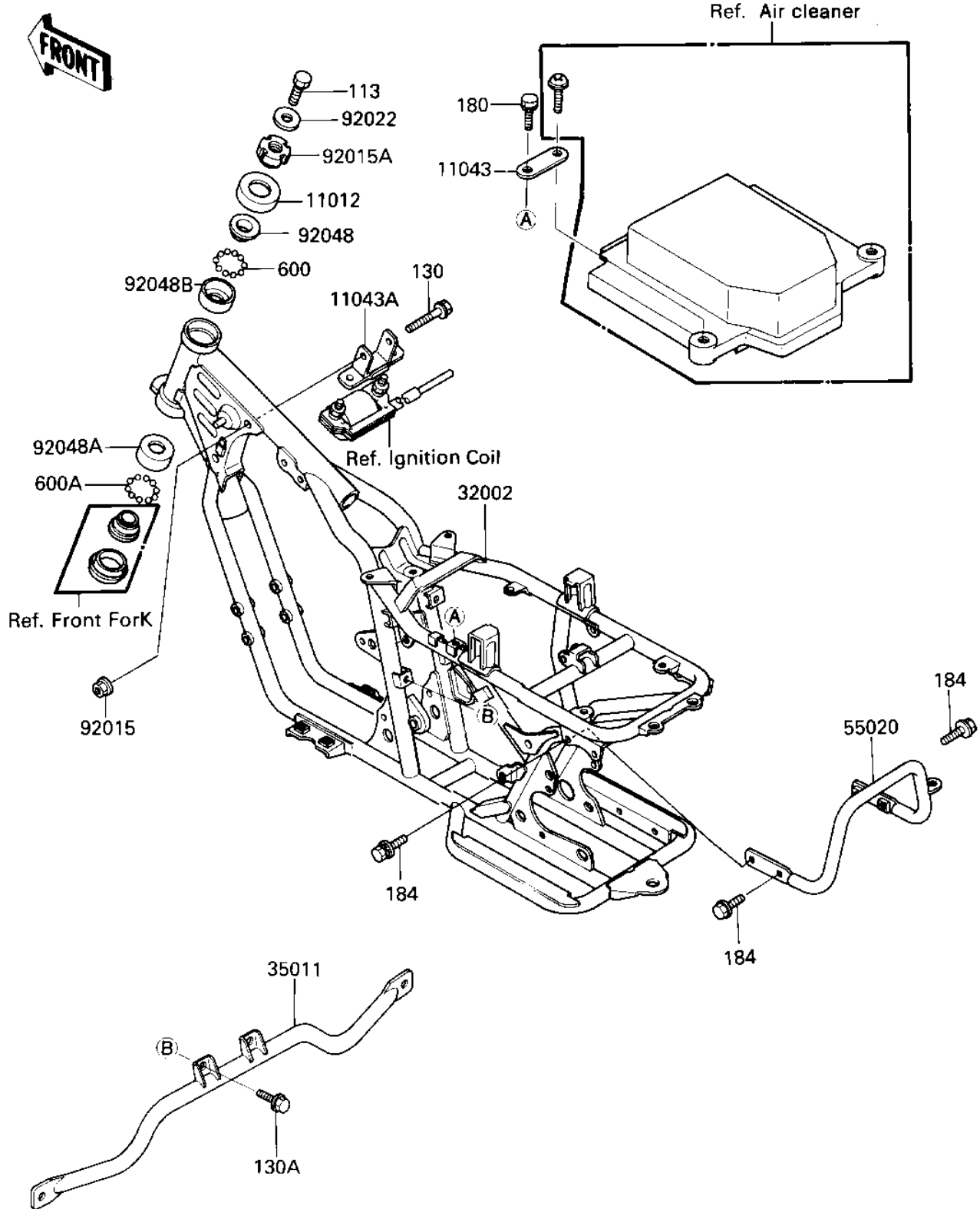

1986 KLT185 PARTS LIST

FRAME

ITEM NAME	PART NUMBER	QUANTITY
CAP,STEERING STEM (Ref # 11012)	46098-012	1
BRACKET,AIR FILTER,LH (Ref # 11043)	11043-1540	1
BRACKET,IGNITION COIL (Ref # 11043A)	11043-1773	1
FRAME-COMP (Ref # 32002)	32002-1848	1
STAY,REAR FENDER (Ref # 35011)	35011-1281	1
GUARD (Ref # 55020)	55020-4017	1
NUT-6MM (Ref # 92015)	92015-1078	1
NUT,STEERING STEM (Ref # 92015A)	92015-4007	1
WASHER,10.5X35X4,BLAC (Ref # 92022)	92022-4028	1
CONE,STRG STM BRG,UP (Ref # 92048)	92047-014	1
RACE STEERING BEARING (Ref # 92048A)	92048-005	1
RACE,STRG STM BEARING (Ref # 92048B)	92048-009	1
BOLT-SMALL-FINE,12X25 (Ref # 113)	113J1225	1
BOLT-FLANGED,6X45 (Ref # 130)	130B0645	1
BOLT-FLANGED,6X10,BLA (Ref # 130A)	130C0610	2
BOLT 6X12 (Ref # 180)	180B0612	1
BOLT-UPSET-WP-SMALL (Ref # 184)	184J0820	4
BALL STEEL 3/16' (Ref # 600)	600A0600	23
BALL STEEL 1/4' (Ref # 600A)	600A0800	19