

1987 KLT185 PARTS DIAGRAM

FRAME FITTINGS

F2131-0191

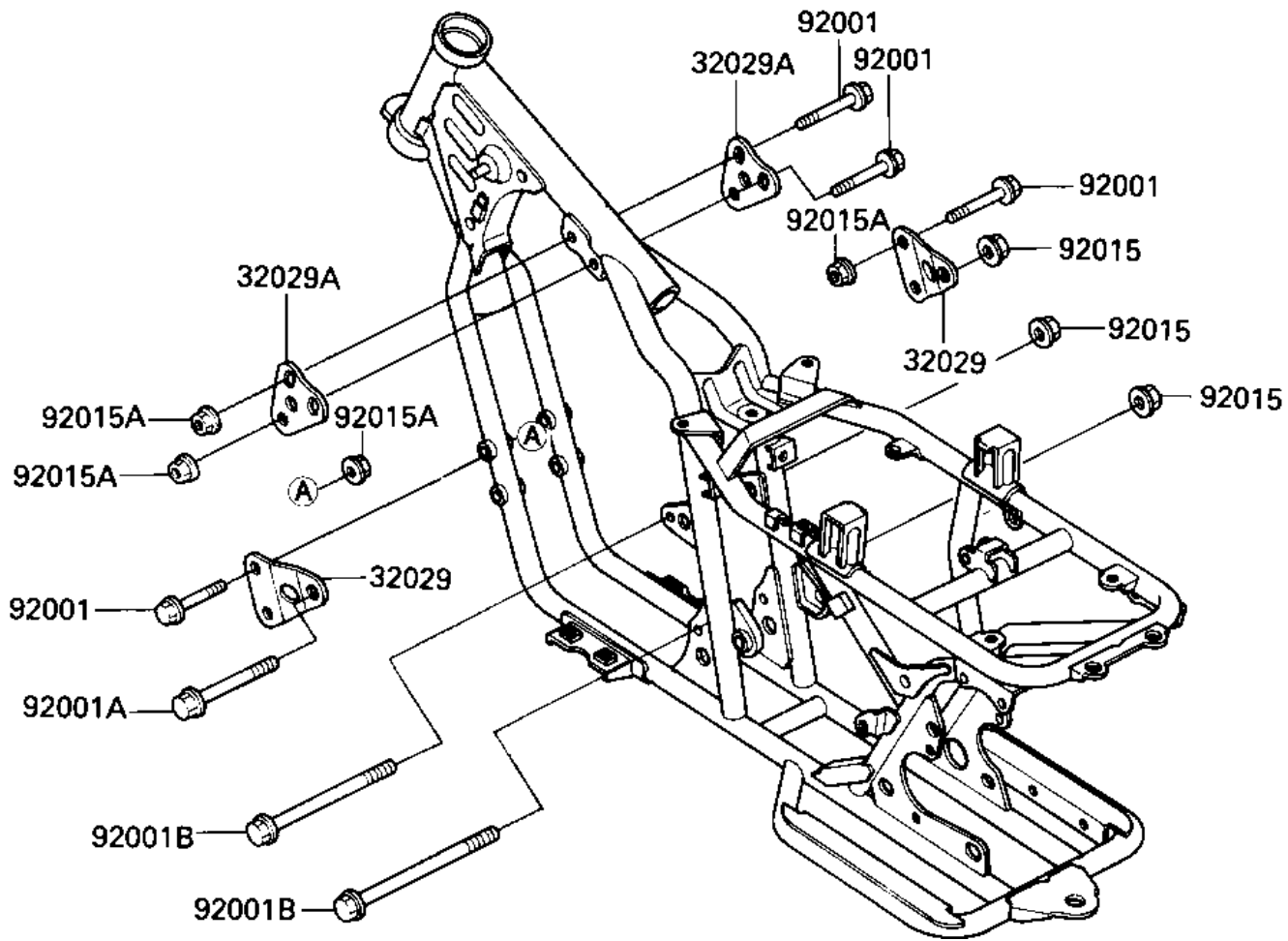

1987 KLT185 PARTS LIST

FRAME FITTINGS

ITEM NAME	PART NUMBER	QUANTITY
BRACKET-ENGINE,FR (Ref # 32029)	32029-1324	2
BRACKET-ENGINE,UPP (Ref # 32029A)	32029-1325	2
BOLT,FLANGED,8X55,BLA (Ref # 92001)	92001-1641	7
BOLT,FLANGED,10X80 (Ref # 92001A)	92001-1709	1
BOLT,FLANGED,10X115,B (Ref # 92001B)	92001-1780	2
NUT,FLANGED,10MM,BLAC (Ref # 92015)	92015-1180	3
NUT,FLANGED,8MM (Ref # 92015A)	92015-1408	7