

1987 Ninja® 250R PARTS DIAGRAM

CRANKSHAFT/BALANCER

E1321-0089

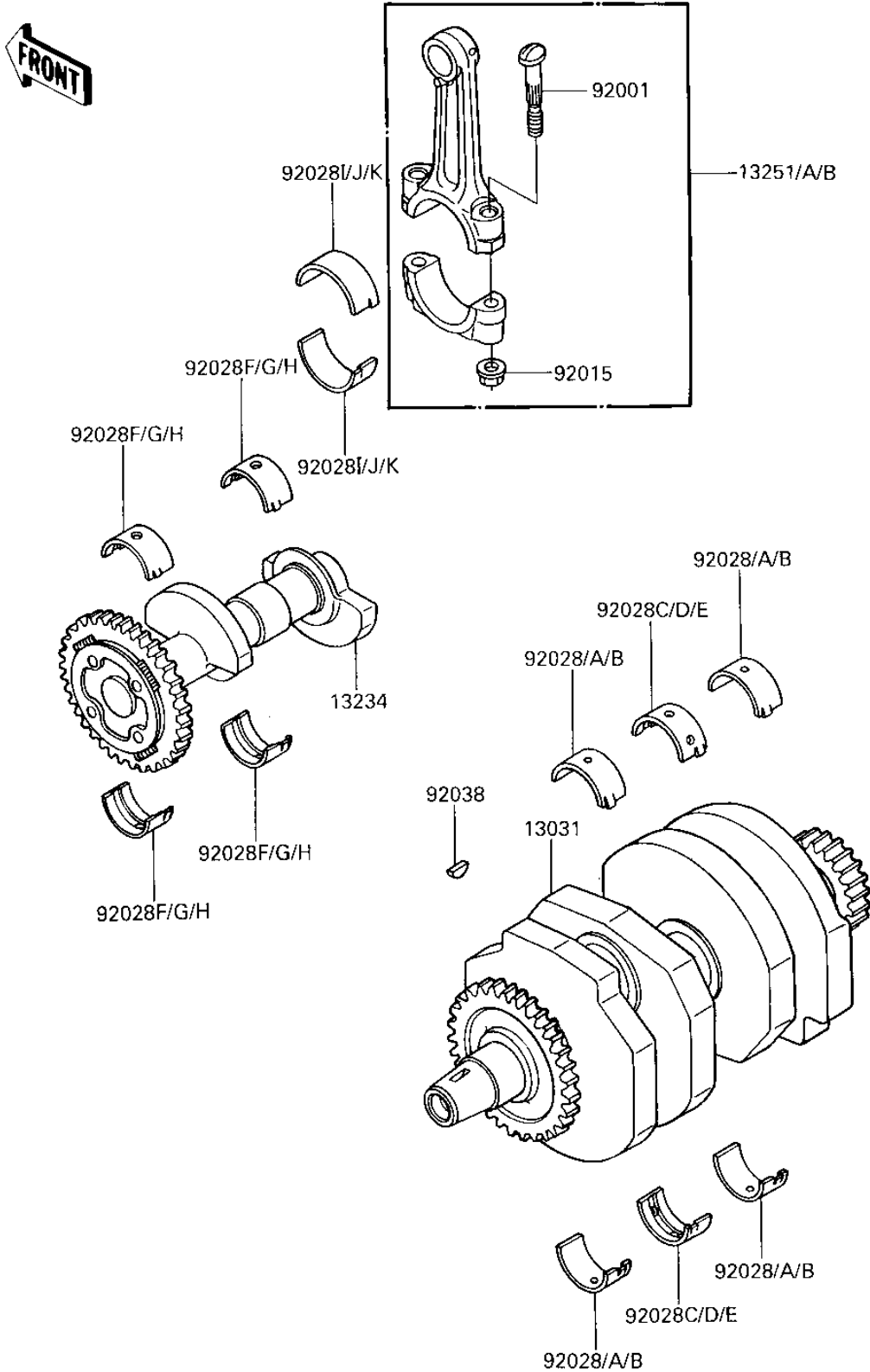

1987 Ninja® 250R PARTS LIST

CRANKSHAFT/BALANCER

ITEM NAME	PART NUMBER	QUANTITY
CRANKSHAFT-COMP (Ref # 13031)	13031-1219	1
SHAFT-COMP,BALANCER (Ref # 13234)	13234-1065	1
ROD-ASSY-CONNECTING,G (Ref # 13251)	13251-1073-GG	2
ROD-ASSY-CONNECTING,G (Ref # 13251A)	13251-1073-GG	2
ROD-ASSY-CONNECTING,G (Ref # 13251B)	13251-1073-GG	2
BOLT,CONNECTING ROD (Ref # 92001)	92001-1793	4
NUT,CONNECTING ROD,8M (Ref # 92015)	92015-1527	4
BUSHING,CRANKSHAFT,#1 (Ref # 92028)	92028-1416	AR
BUSHING,CRANKSHAFT,#1 (Ref # 92028A)	92028-1417	AR
BUSHING,CRANKSHAFT,#1 (Ref # 92028B)	92028-1418	AR
BUSHING,CRANKSHAFT,#2 (Ref # 92028C)	92028-1419	AR
BUSHING,CRANKSHAFT,#2 (Ref # 92028D)	92028-1420	AR
BUSHING,CRANKSHAFT,#2 (Ref # 92028E)	92028-1421	AR
BUSHING,BALANCER,BLUE (Ref # 92028F)	92028-1422	AR
BUSHING,BALANCER,BLAC (Ref # 92028G)	92028-1423	AR
BUSHING,BALANCER,BROW (Ref # 92028H)	92028-1424	AR
BUSHING,CONNECTING RO (Ref # 92028I)	92028-1429	AR
BUSHING,CONNECTING RO (Ref # 92028J)	92028-1430	AR
BUSHING,CONNECTING RO (Ref # 92028K)	92028-1431	AR
WOODRUFF KEY (Ref # 92038)	92038-001	1