

1986 Ninja® PARTS DIAGRAM

CLUTCH

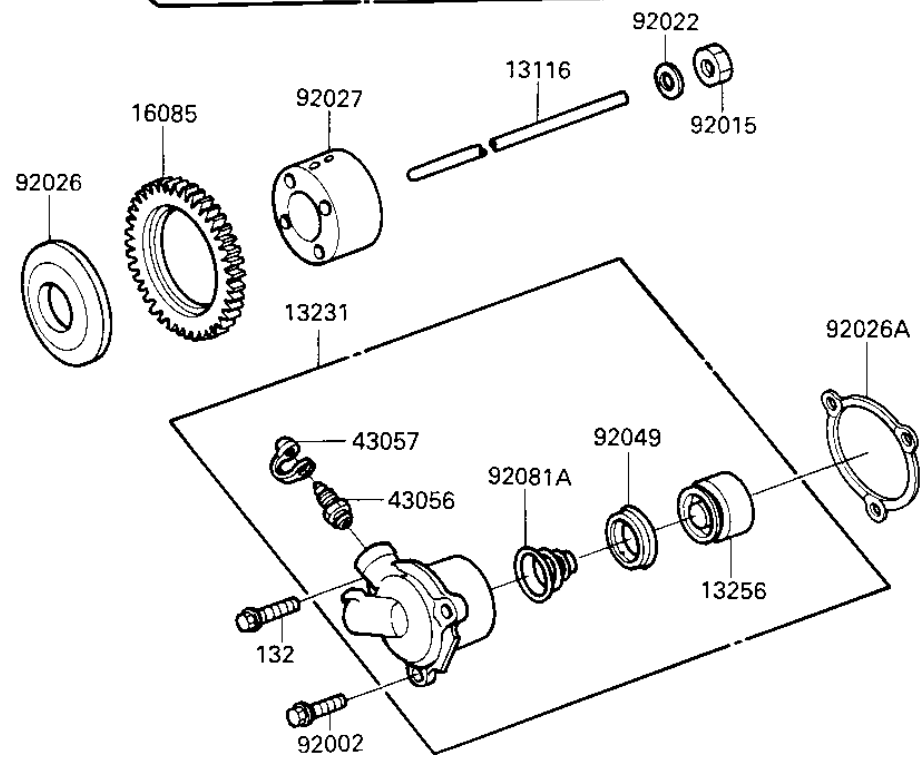
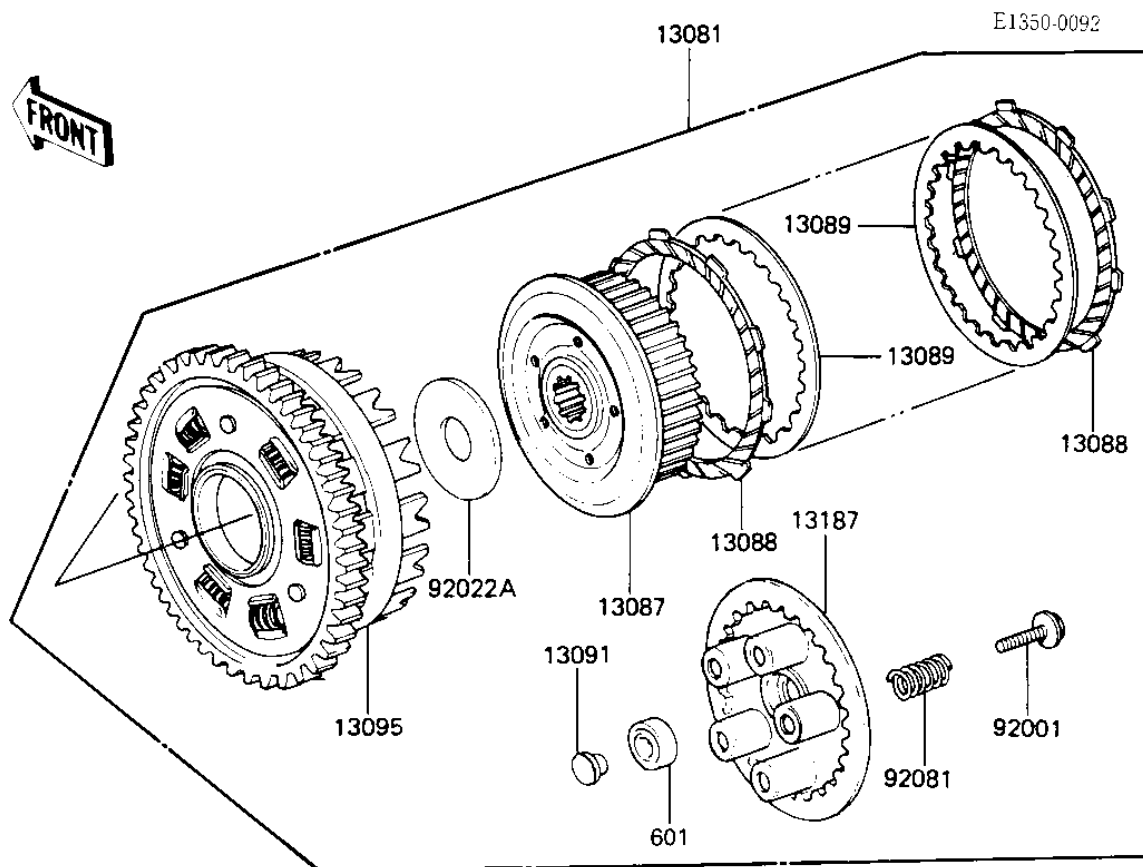

1986 Ninja® PARTS LIST

CLUTCH

ITEM NAME	PART NUMBER	QUANTITY
CLUTCH-ASSY (Ref # 13081)	13081-1175	1
HUB,CLUTCH (Ref # 13087)	13087-042	1
PLATE-FRICTION (Ref # 13088)	13088-1013	8
PLATE,CLUTCH STEL (Ref # 13089)	13089-027	7
HOLDER (Ref # 13091)	13091-1085	1
HOUSING-COMP-CLUTCH (Ref # 13095)	13095-1245	1
ROD-PUSH,CLUTCH (Ref # 13116)	13116-1104	1
PLATE-CLUTCH OPERATIN (Ref # 13187)	13187-1006	1
RELEASE-ASSY-CLUTCH (Ref # 13231)	13231-1066	1
PISTON,CLUTCH RELEASE (Ref # 13256)	13256-1051	1
GEAR,OIL PUMP (Ref # 16085)	16085-1108	1
BREATHER-BRAKE (Ref # 43056)	43056-1052	1
CAP-BREATHER (Ref # 43057)	43057-1001	1
BOLT,CLUTCH SPR FITT (Ref # 92001)	92001-1066	5
BOLT (Ref # 92002)	92002-1613	2
NUT,20MM (Ref # 92015)	92015-1555	1
WASHER,PLAIN,2.3X20.3 (Ref # 92022)	92022-1116	1
WASHER,CLUTCH THRUST (Ref # 92022A)	92022-1592	1
SPACER (Ref # 92026)	92026-5001	1
SPACER,CLUTCH RELEASE (Ref # 92026A)	92026-1263	1
COLLAR (Ref # 92027)	92027-1710	1
SEAL-OIL,PISTON (Ref # 92049)	92049-1165	1
SPRING,CLUTCH (Ref # 92081)	92081-1033	5
SPRING,CLUTCH RELEASE (Ref # 92081A)	92081-1644	1
BOLT-FLANGED-SMALL (Ref # 132)	132J0680	1
BEARING-BALL (Ref # 601)	92045-1235	1