

# 1988 300 SX PARTS DIAGRAM

## Hull Fittings

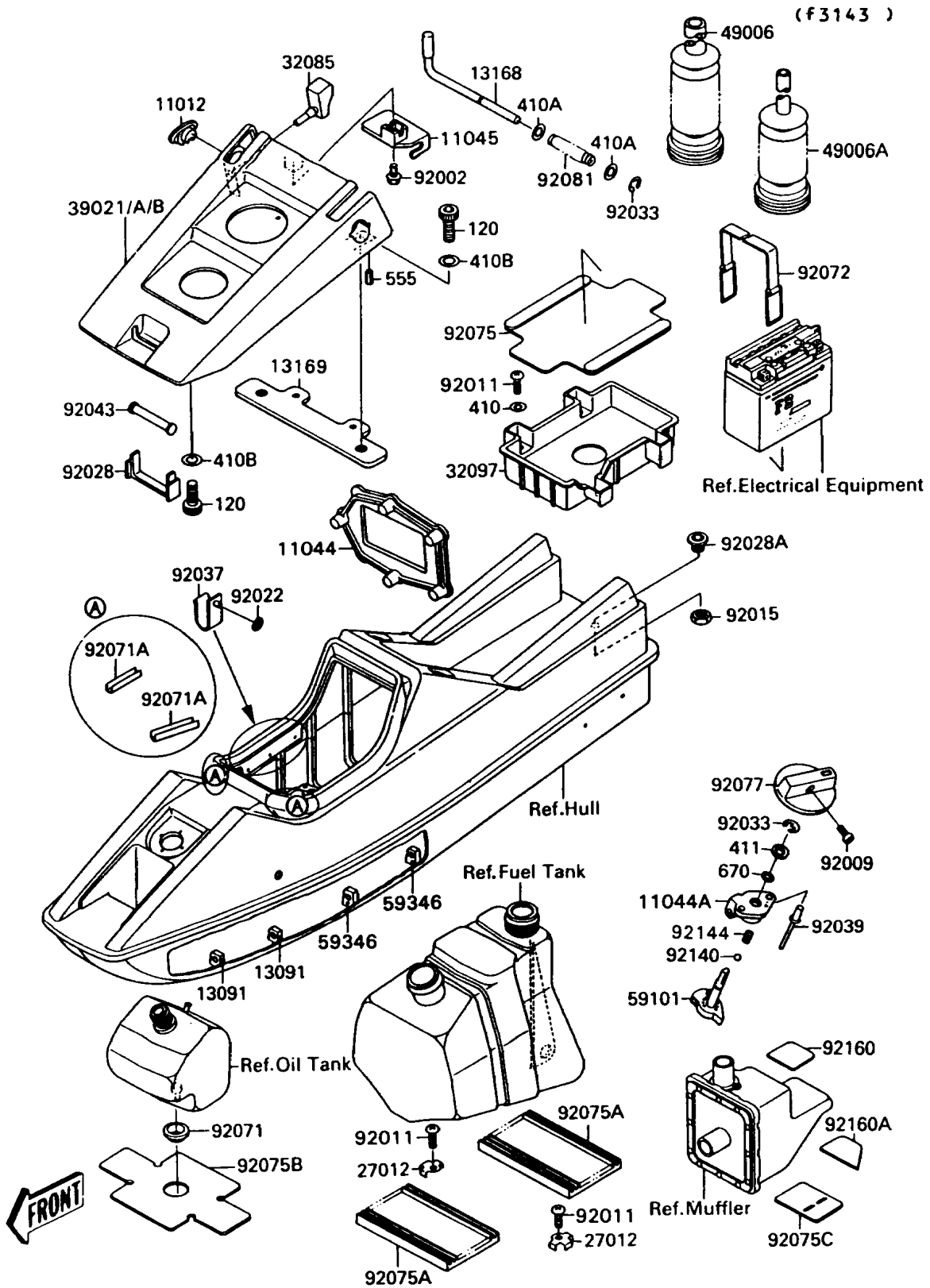

# 1988 300 SX PARTS LIST

## Hull Fittings

ITEM NAME	PART NUMBER	QUANTITY
CAP (Ref # 11012)	11012-3709	2
BRACKET (Ref # 11044)	11044-3703	1
BRACKET (Ref # 11044A)	11044-3704	1
BRACKET (Ref # 11045)	11045-3769	1
HOLDER (Ref # 13091)	13091-3712	2
LEVER (Ref # 13168)	13168-3702	1
PLATE (Ref # 13169)	13169-3703	1
HOOK (Ref # 27012)	27012-501	2
STOPPER (Ref # 32085)	32085-3704	2
CASE-BATTERY (Ref # 32097)	32097-3702	1
BRACKET-HANDLE POLE, JET WHITE (Ref # 39021A)	39021-3702-8C	1
BOOT (Ref # 49006)	49006-3703	1
BOOT (Ref # 49006A)	49006-3704	1
REEL, CHOKE (Ref # 59101)	59101-3702	1
DETENT (Ref # 59346)	59346-504	2
BOLT, 6X12 (Ref # 92002)	92002-3763	1
SCREW, 4X8 (Ref # 92009)	92009-3729	1
SCREW, TAPPING (Ref # 92011)	92011-561	6
NUT (Ref # 92015)	92015-3779	1
WASHER, LOCK, 5MM (Ref # 92022)	92022-3723	3
BUSHING (Ref # 92028)	92028-3712	1
BUSHING (Ref # 92028A)	92028-3734	1
RING-SNAP, 7MM (Ref # 92033)	92033-3704	2
CLAMP, FUEL TUBE (Ref # 92037)	92037-3720	3
RIVET (Ref # 92039)	92039-3714	2
PIN (Ref # 92043)	92043-3706	1
GROMMET, OIL TANK (Ref # 92071)	92071-3720	1
GROMMET, L=100 (Ref # 92071A)	92071-3744	2
BAND, BATTERY, L=366 (Ref # 92072)	92072-3706	2

# 1988 300 SX PARTS LIST

## Hull Fittings

ITEM NAME	PART NUMBER	QUANTITY
DAMPER,BATTERY (Ref # 92075)	92075-3714	1
DAMPER (Ref # 92075A)	92075-3716	2
DAMPER,OIL TANK (Ref # 92075B)	92075-3717	1
DAMPER,MUFFLER (Ref # 92075C)	92075-3747	1
KNOB,FUEL TAP (Ref # 92077)	92077-3704	1
SPRING (Ref # 92081)	92081-3703	1
BALL,3MM (Ref # 92140)	92140-3702	2
SPRING (Ref # 92144)	92144-3712	2
DAMPER (Ref # 92160)	92160-3714	1
DAMPER (Ref # 92160A)	92160-3715	1
BOLT-SOCKET (Ref # 120)	120R1025	4
WASHER-PLAIN-SMALL,6MM (Ref # 410)	410S0600	4
WASHER-PLAIN-SMALL,8MM (Ref # 410A)	410S0800	2
W-PLAIN-S,10MM (Ref # 410B)	410S1000	4
WASHER-PLAIN,8MM (Ref # 411)	411S0800	1
PIN-SPRING,4X14 (Ref # 555)	555B0414	2
O RING,8MM (Ref # 670)	670B1508	1