

1987 KX250 PARTS DIAGRAM

REAR SUSPENSION

F2150-0077

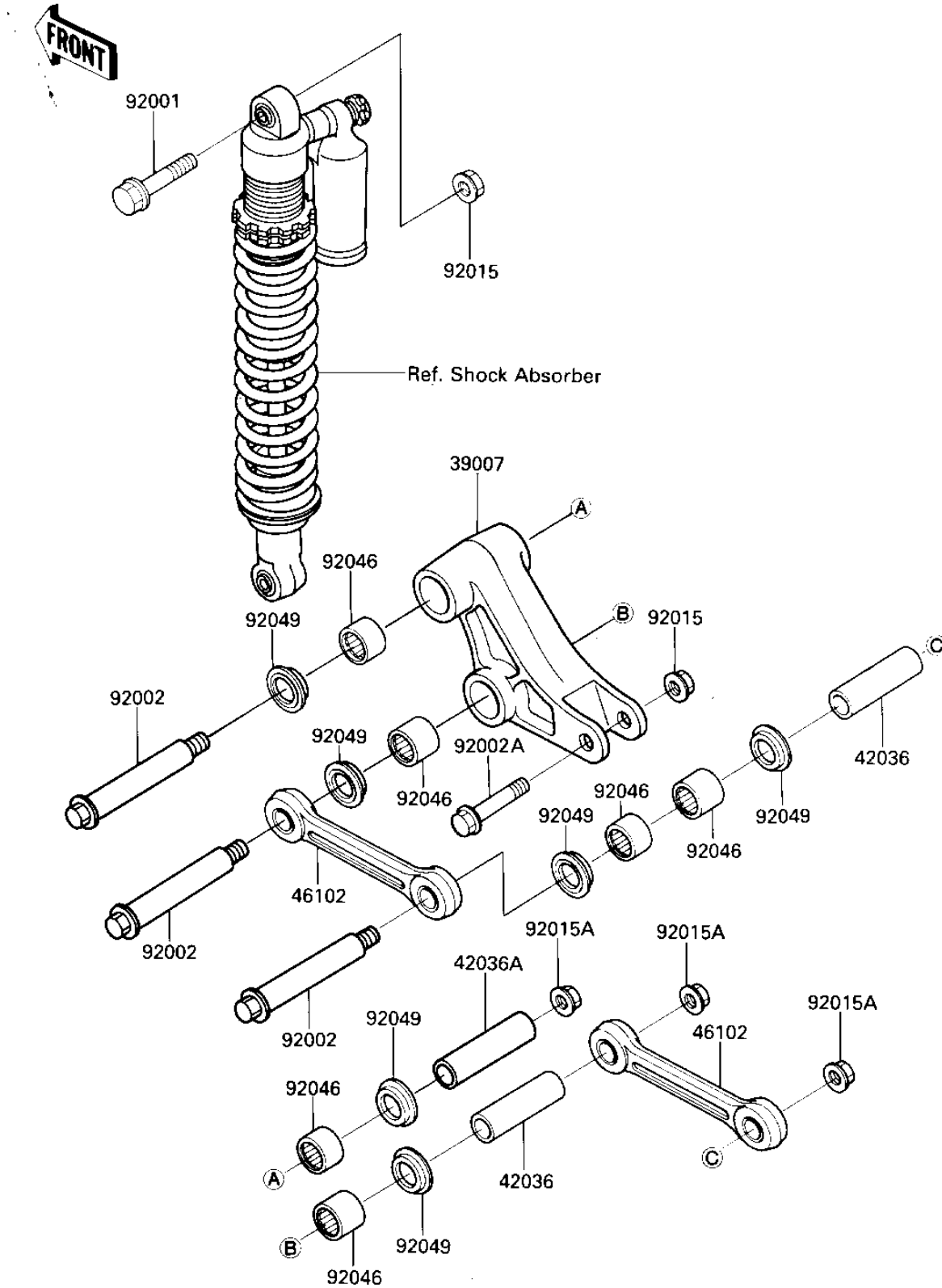

1987 KX250 PARTS LIST

REAR SUSPENSION

ITEM NAME	PART NUMBER	QUANTITY
ARM-SUSP,UNI TRAK (Ref # 39007)	39007-1115	1
SLEEVE,22X65 (Ref # 42036)	42036-1209	2
SLEEVE,22X72 (Ref # 42036A)	42036-1210	1
ROD (Ref # 46102)	46102-1200	2
BOLT,10X50 (Ref # 92001)	92001-1913	1
BOLT,12MM (Ref # 92002)	92002-1890	3
BOLT (Ref # 92002A)	92002-1936	1
NUT,10MM (Ref # 92015)	92015-1415	2
NUT,LOCK,12MM (Ref # 92015A)	92015-1617	6
BEARING-NEEDLE (Ref # 92046)	92046-1162	6
SEAL-OIL,MHA22 28 5.7 (Ref # 92049)	92049-1254	6